

UCIP 213 ASAHI

Ball bearing units

TYPE: Housing units, Plummer block, Cast iron housing, Radial insert ball bearing with grub screws in inner ring, Type UCIP (ASAHI)

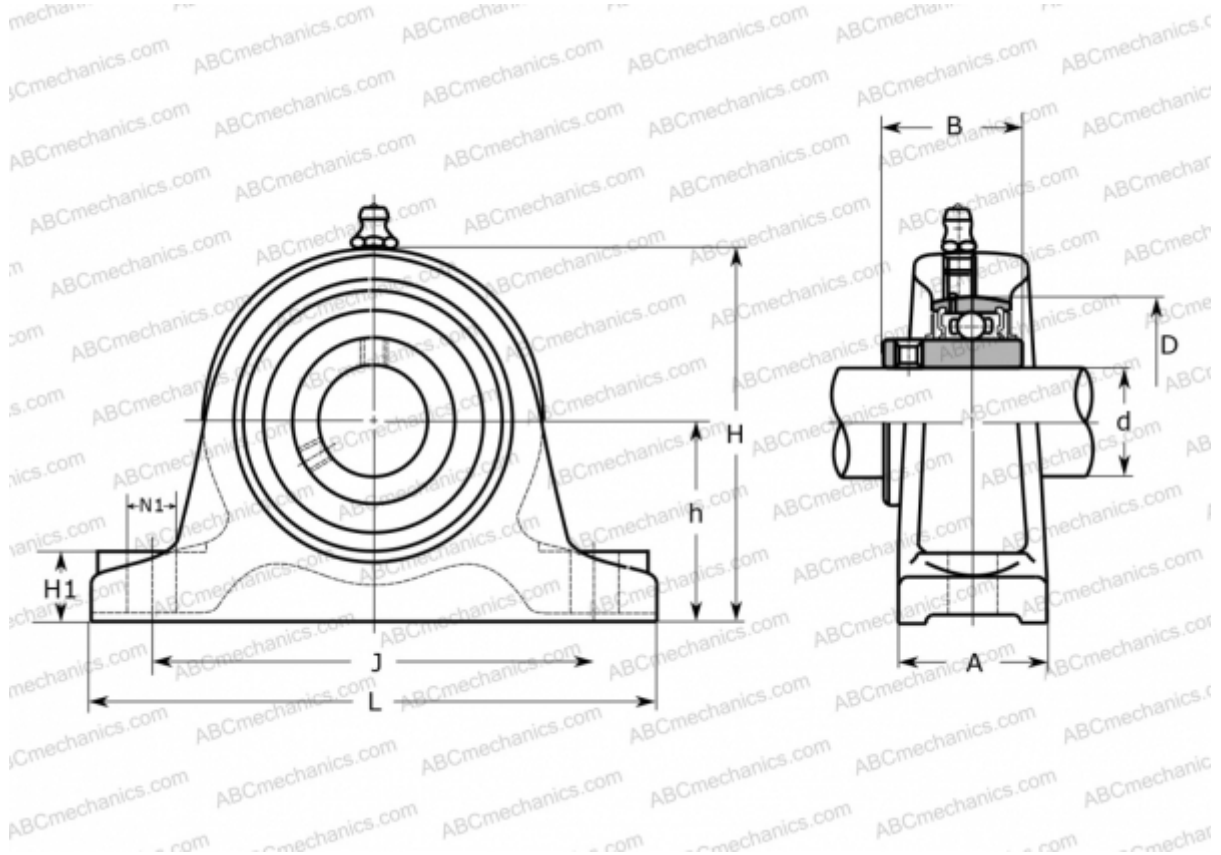

Technical specification

DIMENSIONS, MM

d	65,000
D	120,000
B	65,100
L	280,000
H	172,000
A	70,000
J	220,000
H1	30,000
N1	22,000
h	90,000

MANUFACTURER

[ASAHI](#)

WEIGHT, KG

7,500

Bearing	UC 213
Housing	IP 213