

## UCIP 314 ASAHI

Ball bearing units

TYPE: Housing units, Plummer block, Cast iron housing, Radial insert ball bearing with grub screws in inner ring, Type UCIP (ASAHI)

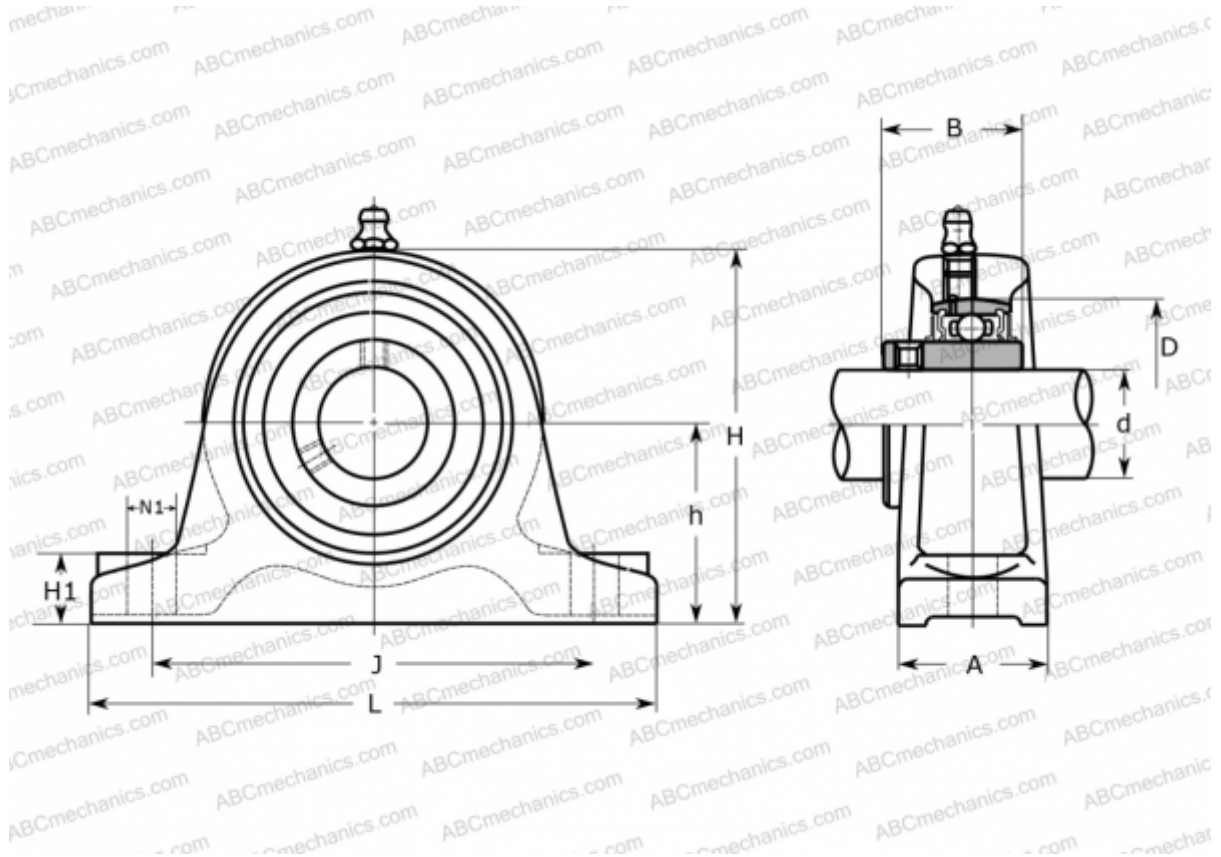

### Technical specification

#### DIMENSIONS, MM

d	70,000
D	150,000
B	78,000
L	330,000
H	215,000
A	75,000
J	270,000
H1	35,000
N1	25,000
h	110,000

#### MANUFACTURER

[ASAHI](#)

#### WEIGHT, KG

14,900

Bearing	UC 314
Housing	IP 314