

UCIP 315 ASAHI

Ball bearing units

TYPE: Housing units, Plummer block, Cast iron housing, Radial insert ball bearing with grub screws in inner ring, Type UCIP (ASAHI)

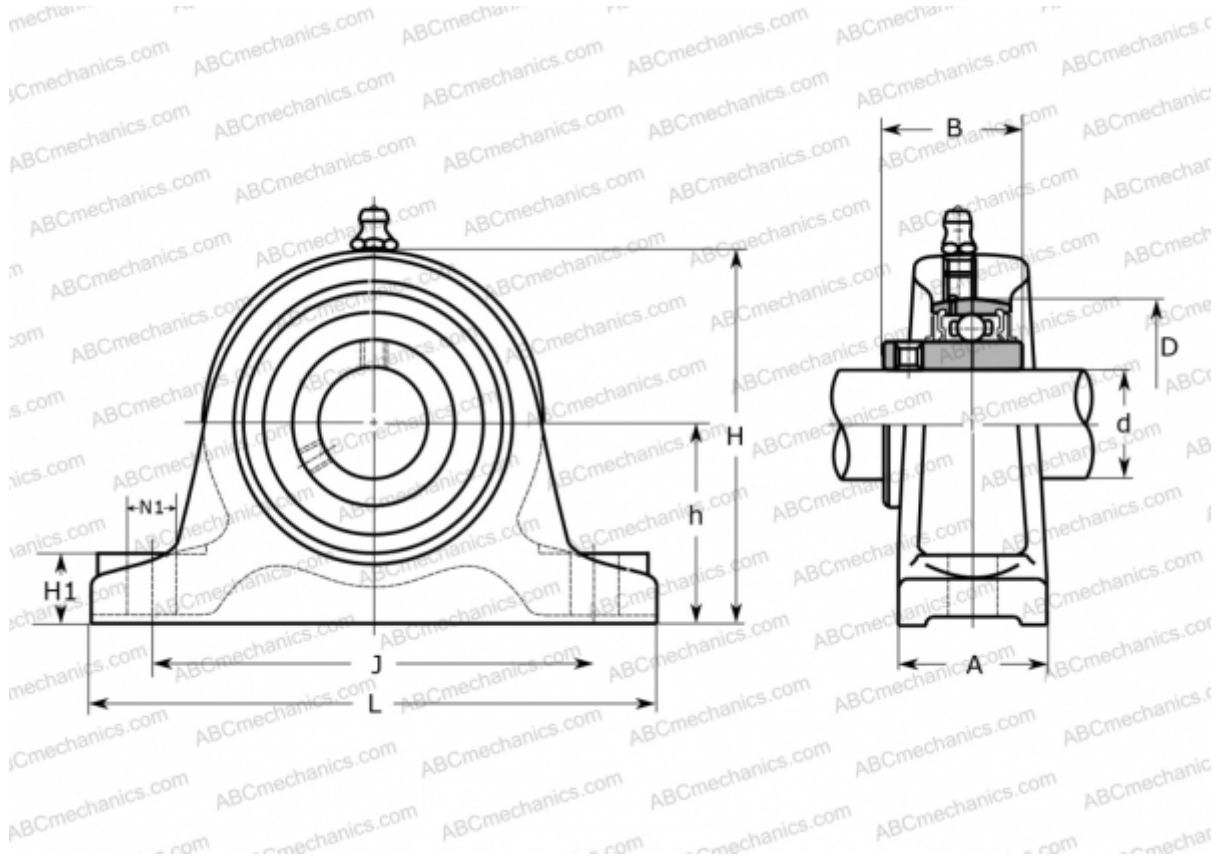

Technical specification

DIMENSIONS, MM

d	75,000
D	160,000
B	82,000
L	340,000
H	230,000
A	75,000
J	280,000
H1	35,000
N1	25,000
h	120,000

MANUFACTURER

[ASAHI](#)

WEIGHT, KG

16,200

Bearing	UC 315
Housing	IP 315