

UCIP 316 ASAHI

Ball bearing units

TYPE: Housing units, Plummer block, Cast iron housing, Radial insert ball bearing with grub screws in inner ring, Type UCIP (ASAHI)

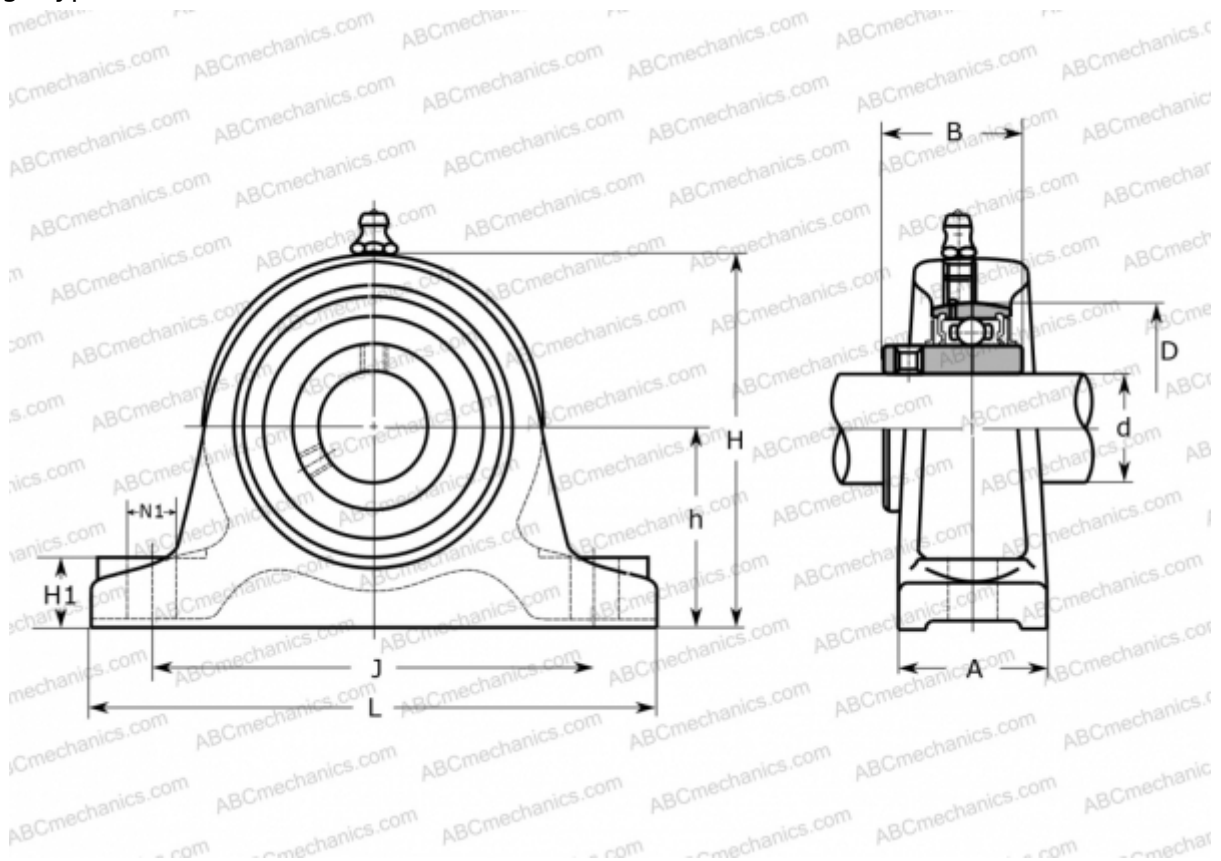

Technical specification

DIMENSIONS, MM

d	80,000
D	170,000
B	86,000
L	350,000
H	235,000
A	85,000
J	290,000
H1	40,000
N1	25,000
h	120,000

MANUFACTURER

[ASAHI](http://www.asahi.com)

WEIGHT, KG

20,800

Bearing	UC 316
Housing	IP 316