

UCIP 317 ASAHI

Ball bearing units

TYPE: Housing units, Plummer block, Cast iron housing, Radial insert ball bearing with grub screws in inner ring, Type UCIP (ASAHI)

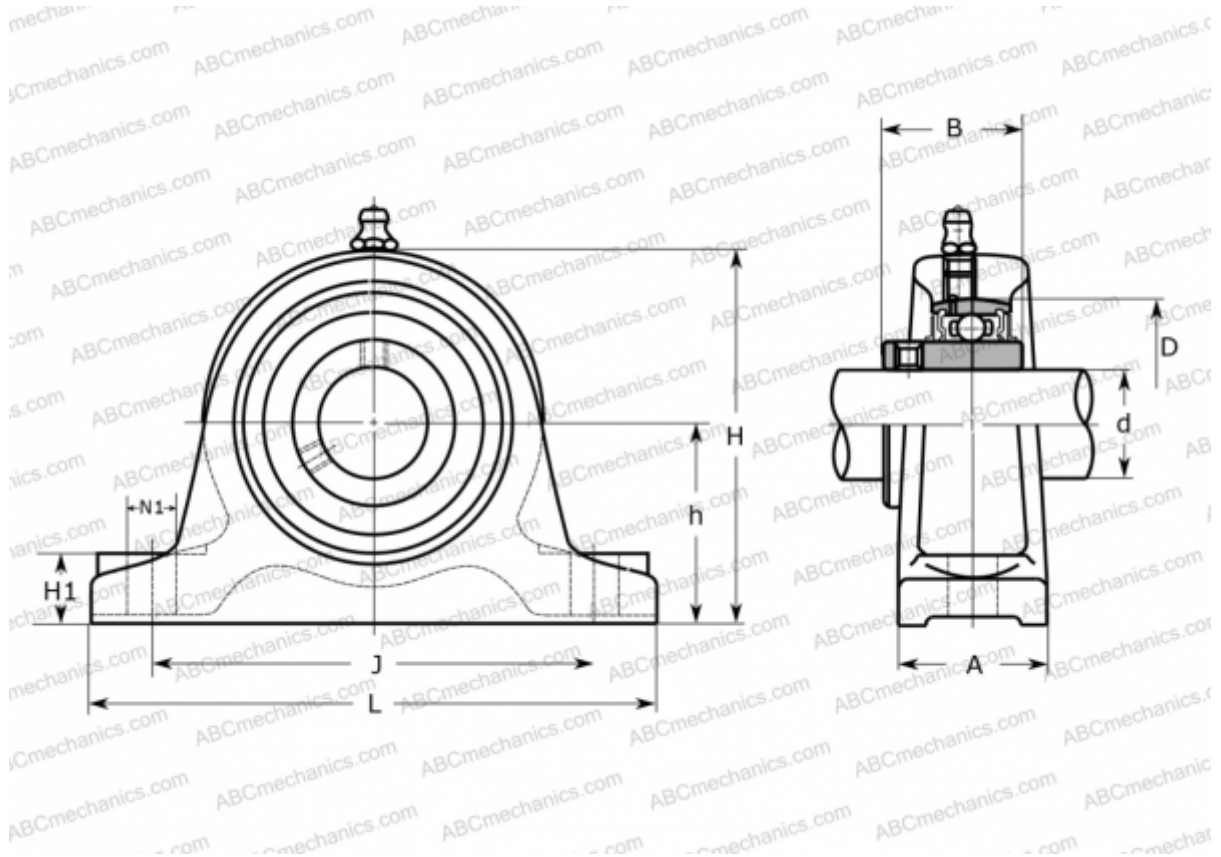

Technical specification

DIMENSIONS, MM

d	85,000
D	180,000
B	96,000
L	370,000
H	255,000
A	85,000
J	310,000
H1	40,000
N1	25,000
h	130,000

MANUFACTURER

[ASAHI](#)

WEIGHT, KG

23,100

Bearing	UC 317
Housing	IP 317