

UCIP 318 ASAHI

Ball bearing units

TYPE: Housing units, Plummer block, Cast iron housing, Radial insert ball bearing with grub screws in inner ring, Type UCIP (ASAHI)

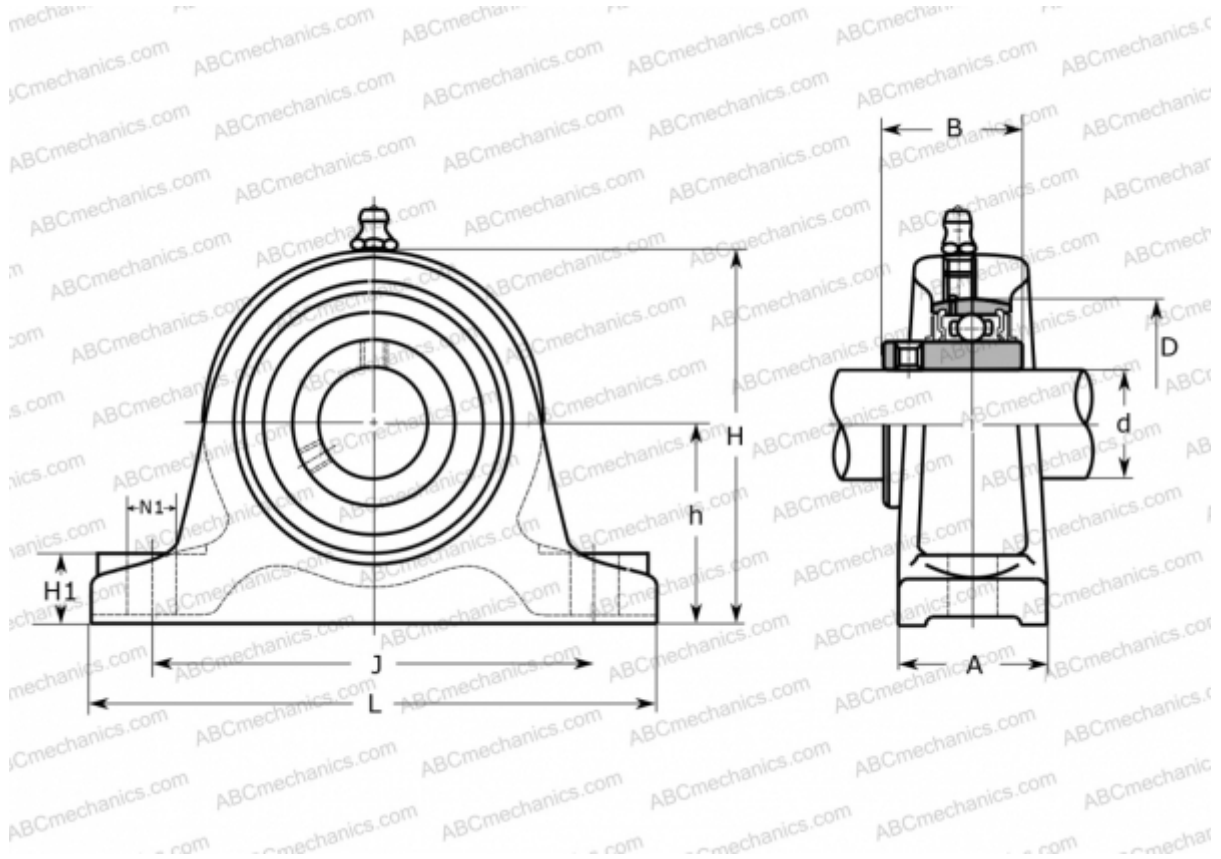

Technical specification

DIMENSIONS, MM

d	90,000
D	190,000
B	96,000
L	400,000
H	260,000
A	85,000
J	330,000
H1	45,000
N1	29,000
h	130,000

MANUFACTURER

[ASAHI](#)

WEIGHT, KG

25,700

Bearing	UC 318
Housing	IP 318