

UCIP 319 ASAHI

Ball bearing units

TYPE: Housing units, Plummer block, Cast iron housing, Radial insert ball bearing with grub screws in inner ring, Type UCIP (ASAHI)

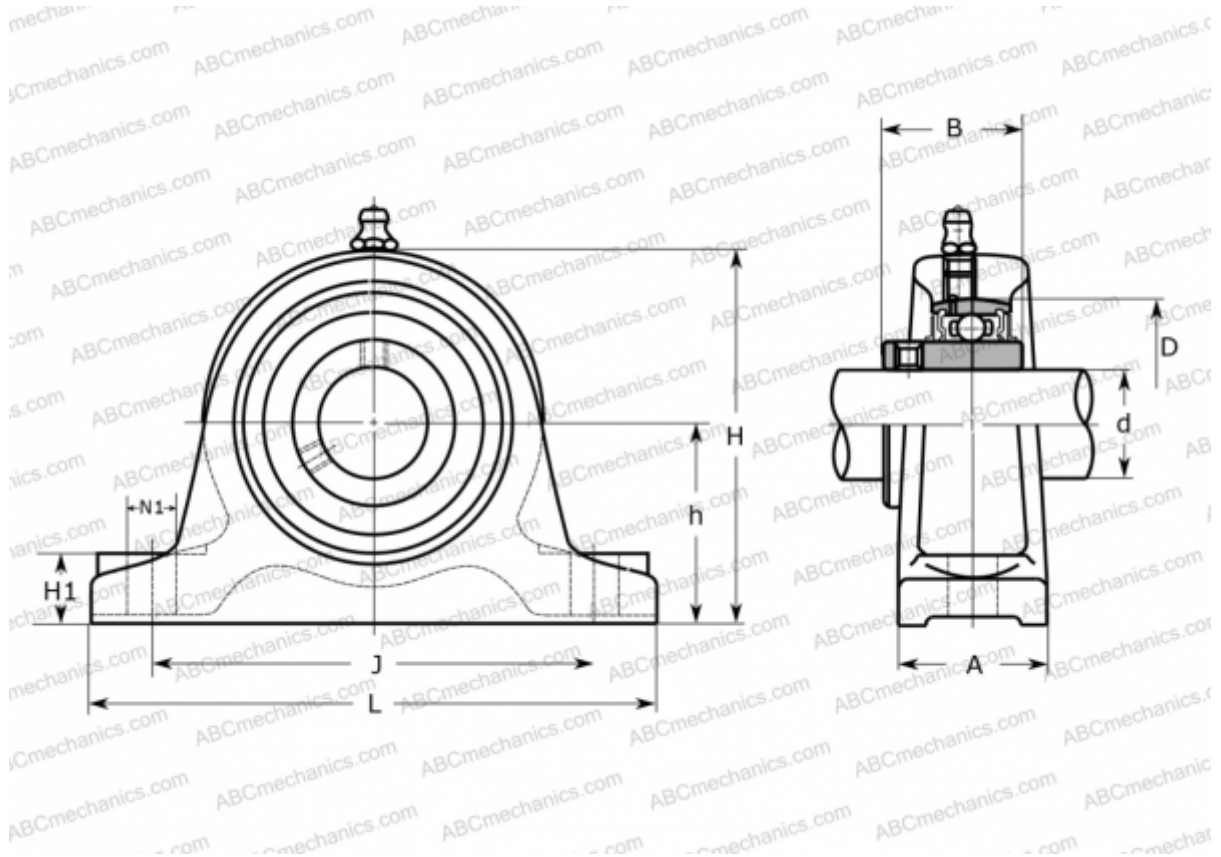

Technical specification

DIMENSIONS, MM

d	95,000
D	200,000
B	103,000
L	410,000
H	285,000
A	85,000
J	340,000
H1	45,000
N1	29,000
h	150,000

MANUFACTURER

[ASAHI](#)

WEIGHT, KG

29,700

Bearing	UC 319
Housing	IP 319