

UCIP 320 ASAHI

Ball bearing units

TYPE: Housing units, Plummer block, Cast iron housing, Radial insert ball bearing with grub screws in inner ring, Type UCIP (ASAHI)

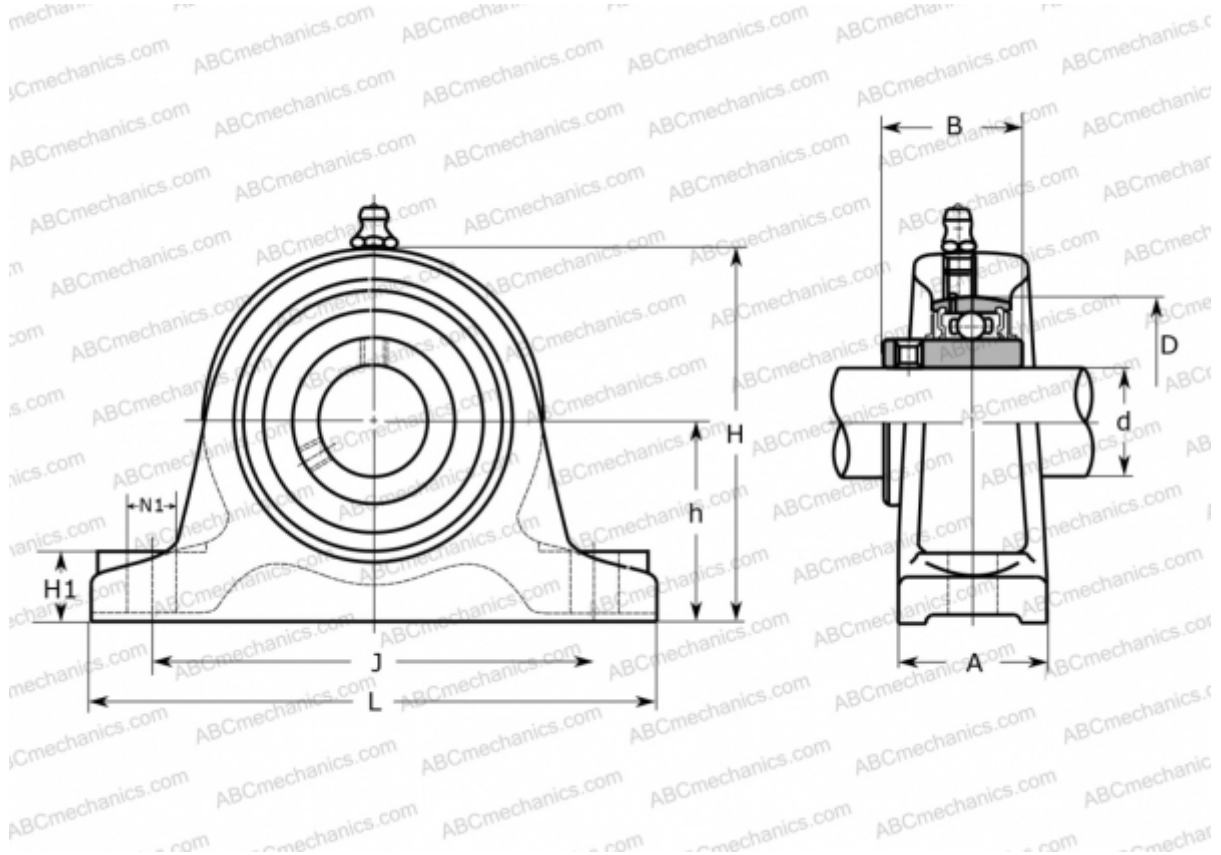

Technical specification

DIMENSIONS, MM

d	100,000
D	215,000
B	108,000
L	430,000
H	295,000
A	85,000
J	360,000
H1	45,000
N1	29,000
h	150,000

MANUFACTURER

[ASAHI](#)

WEIGHT, KG

33,400

Bearing	UC 320
Housing	IP 320