

UCIP 328 ASAHI

Ball bearing units

TYPE: Housing units, Plummer block, Cast iron housing, Radial insert ball bearing with grub screws in inner ring, Type UCIP (ASAHI)

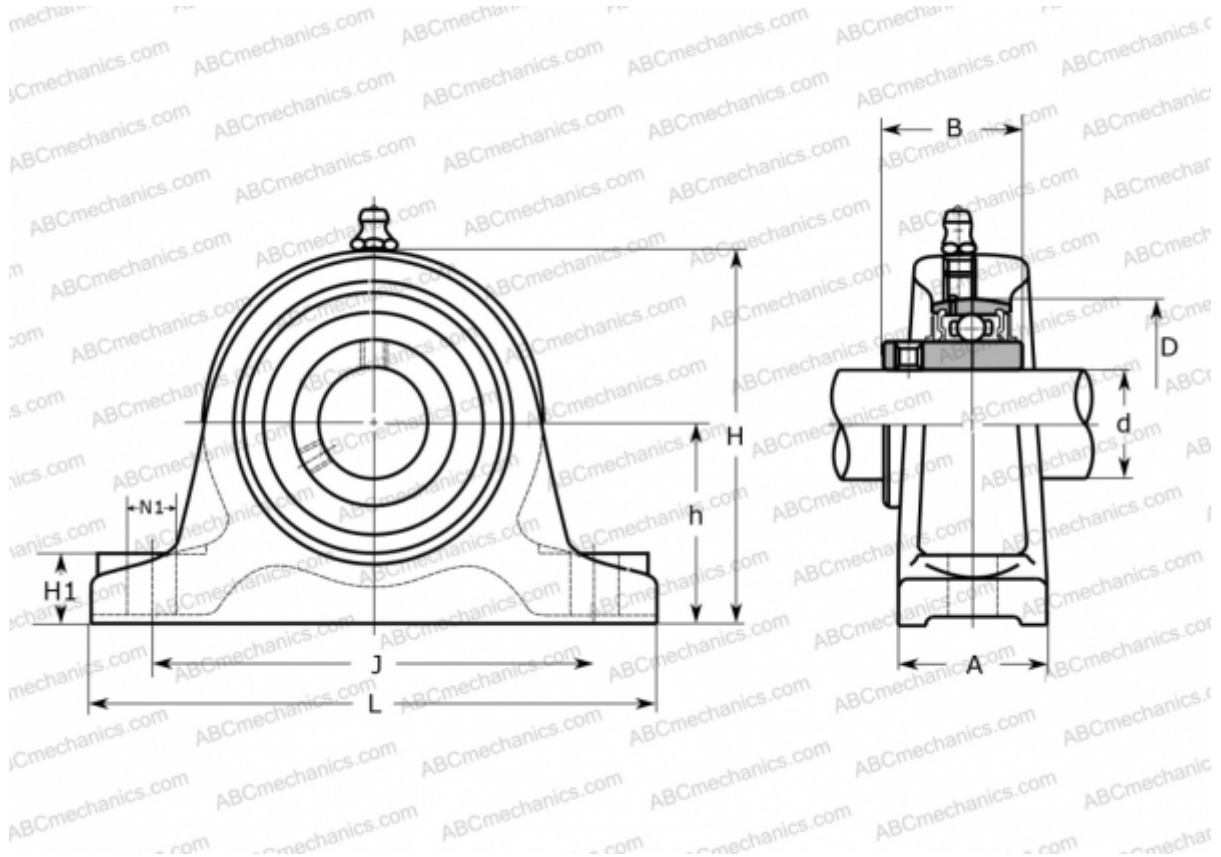

Technical specification

DIMENSIONS, MM

d	140,000
D	300,000
B	145,000
L	590,000
H	400,000
A	110,000
J	500,000
H1	55,000
N1	35,000
h	200,000

MANUFACTURER

[ASAHI](#)

WEIGHT, KG

83,500

Bearing	UC 328
Housing	IP 328