

## UCPH 203 ASAHI

Ball bearing units

TYPE: Housing units, Plummer block, Cast iron housing, Radial insert ball bearing with grub screws in inner ring, Type UCPH (ASAHI)

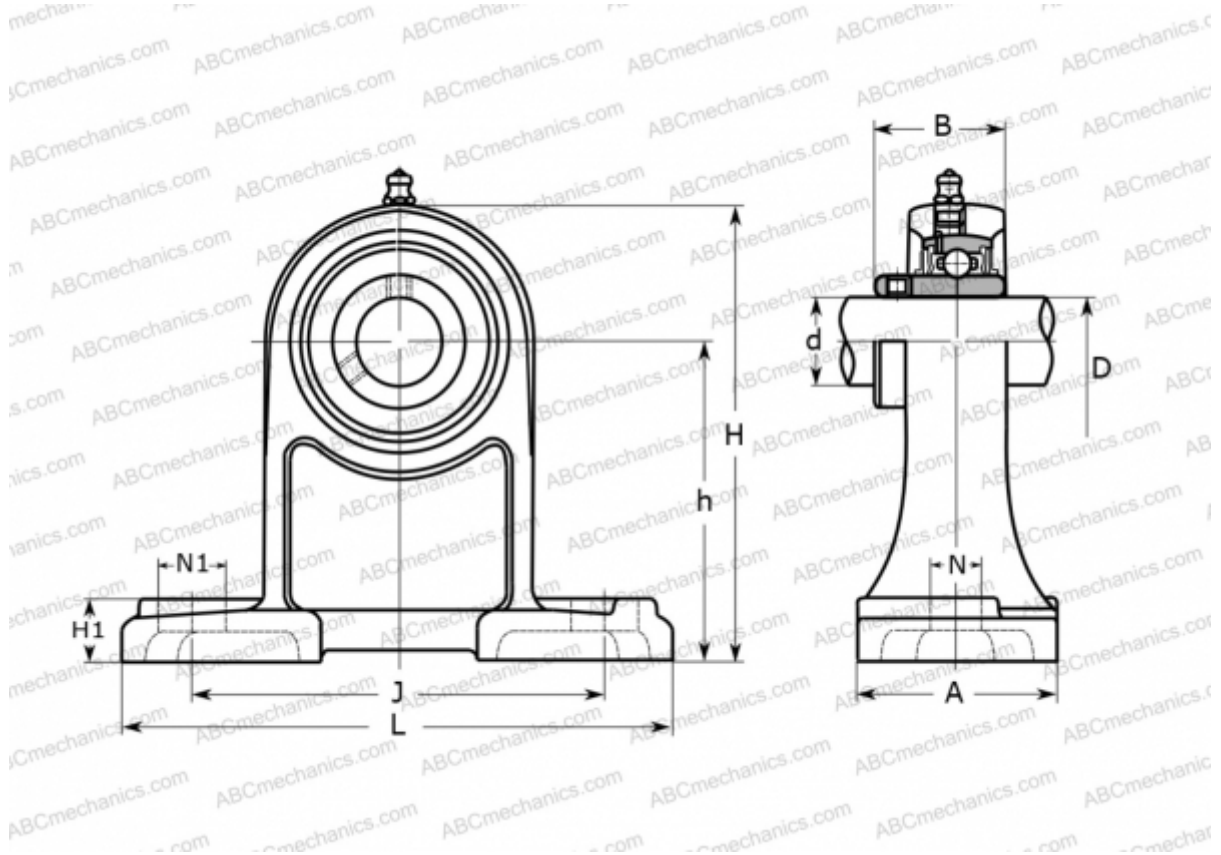

### Technical specification

#### DIMENSIONS, MM

d	17,000
D	47,000
B	31,000
L	127,000
H	101,000
A	40,000
J	95,000
H1	15,000
N	13,000
N1	19,000
h	70,000

#### WEIGHT, KG

Bearing	0,980
	UC 203

Housing

PH 204

#### MANUFACTURER

[ASAHI](http://www.asahi.com)