

UCPA 202 ASAHI

Ball bearing units

TYPE: Housing units, Plummer block, Narrow cast iron housing, Radial insert ball bearing with grub screws in inner ring, Type UCPA (ASAHI)

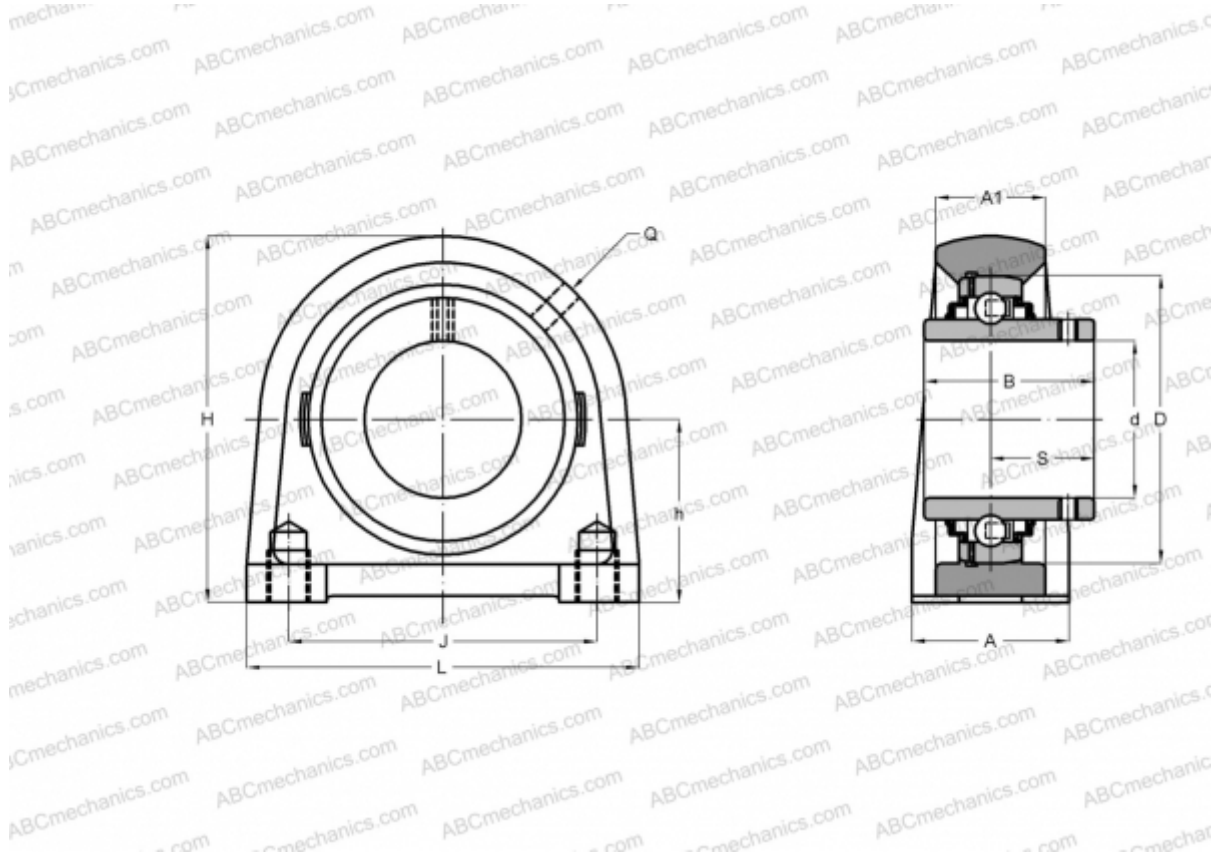

Technical specification

DIMENSIONS, MM

d	15,000
D	47,000
B	31,000
L	76,000
H	62,000
A	38,000
J	52,000
S	18,300
h	30,200

WEIGHT, KG

0,630

Bearing	UC 202
Housing	PA 204

MANUFACTURER

[ASAHI](#)