

UCPA 205 ASAHI

Ball bearing units

TYPE: Housing units, Plummer block, Narrow cast iron housing, Radial insert ball bearing with grub screws in inner ring, Type UCPA (ASAHI)

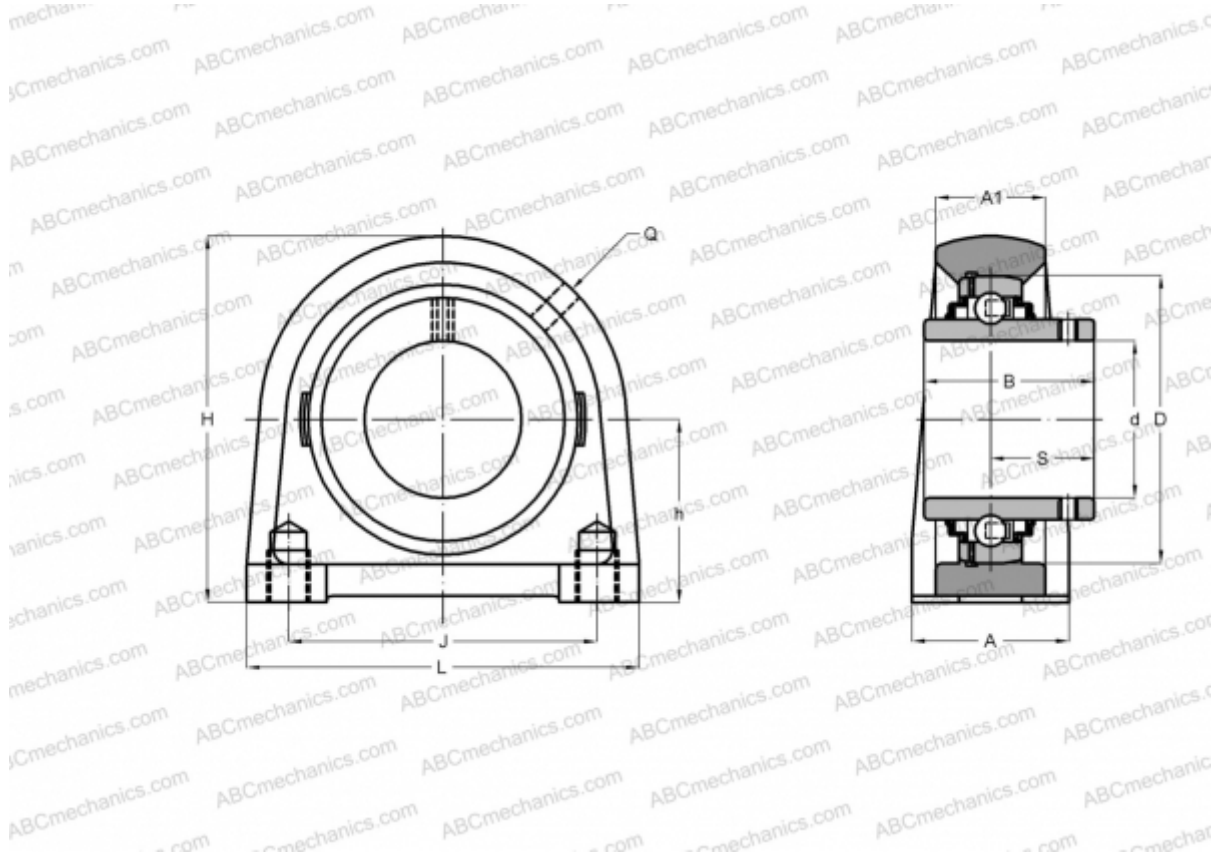

Technical specification

DIMENSIONS, MM

d	25,000
D	52,000
B	34,100
L	84,000
H	72,000
A	38,000
J	56,000
S	19,800
h	36,500

WEIGHT, KG

0,810

Bearing	UC 205
Housing	PA 205

MANUFACTURER

[ASAHI](#)