

UCPA 206 ASAHI

Ball bearing units

TYPE: Housing units, Plummer block, Narrow cast iron housing, Radial insert ball bearing with grub screws in inner ring, Type UCPA (ASAHI)

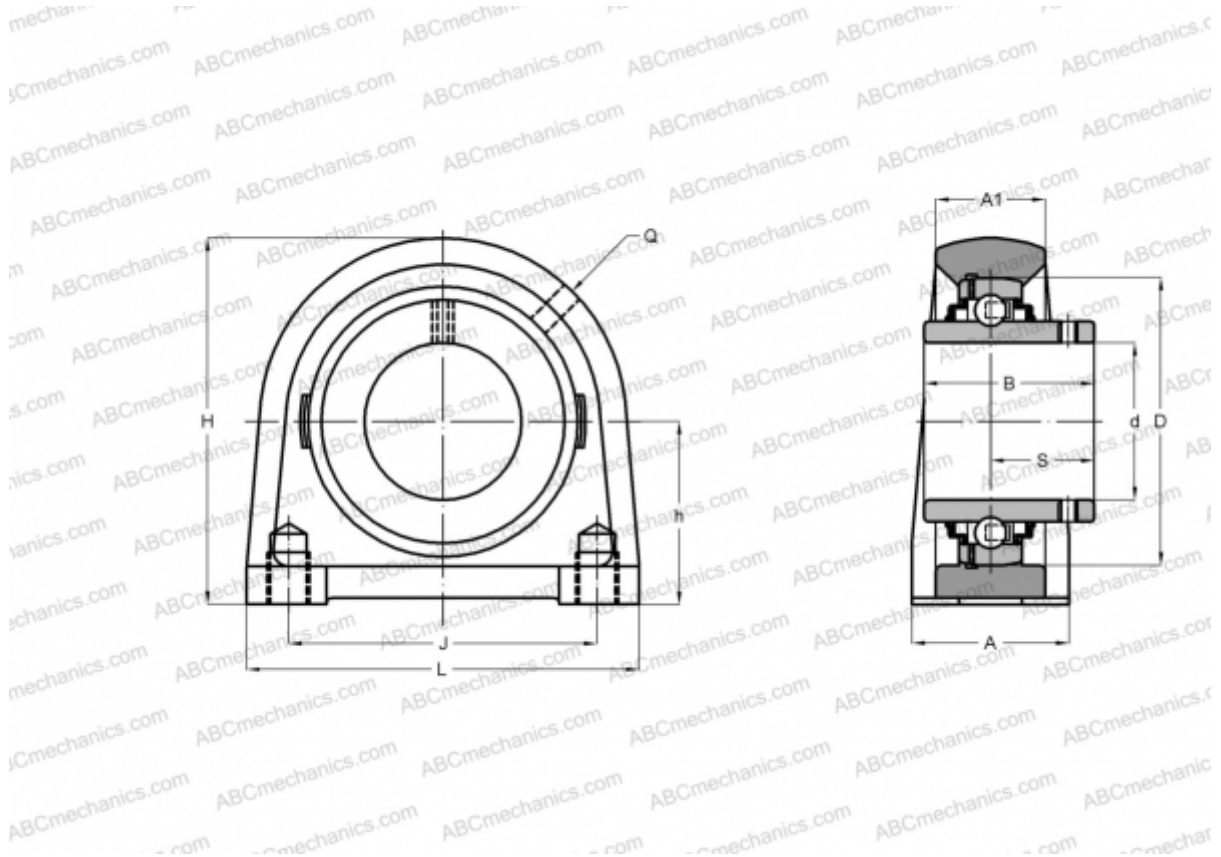

Technical specification

DIMENSIONS, MM

d	30,000
D	62,000
B	38,100
L	94,000
H	84,000
A	48,000
J	66,000
S	22,200
h	42,900

WEIGHT, KG

	1,200
Bearing	UC 206
Housing	PA 206

MANUFACTURER

[ASAHI](#)