

UCPA 207 ASAHI

Ball bearing units

TYPE: Housing units, Plummer block, Narrow cast iron housing, Radial insert ball bearing with grub screws in inner ring, Type UCPA (ASAHI)

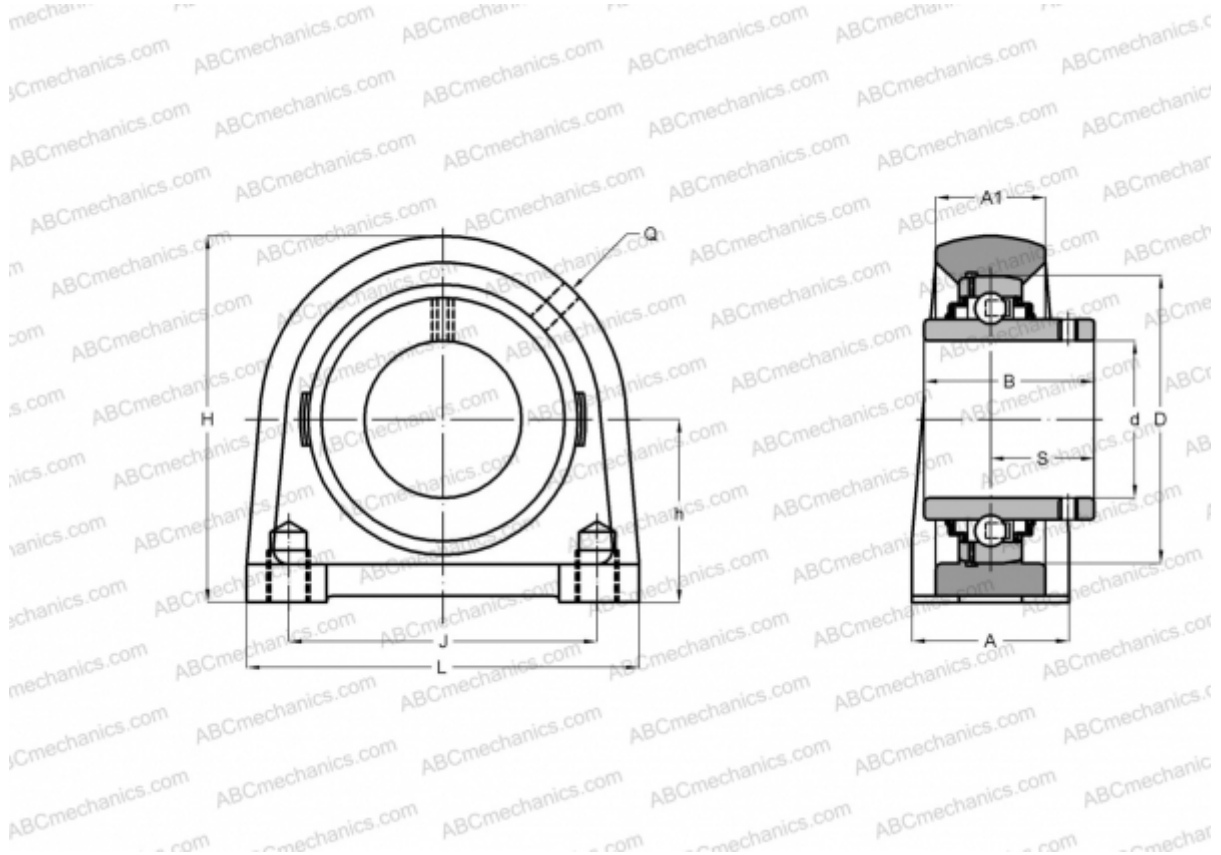

Technical specification

DIMENSIONS, MM

d	35,000
D	72,000
B	42,900
L	110,000
H	95,000
A	48,000
J	80,000
S	25,400
h	47,600

WEIGHT, KG

1,700

Bearing	UC 207
Housing	PA 207

MANUFACTURER

[ASAHI](#)