

UCPA 209 ASAHI

Ball bearing units

TYPE: Housing units, Plummer block, Narrow cast iron housing, Radial insert ball bearing with grub screws in inner ring, Type UCPA (ASAHI)

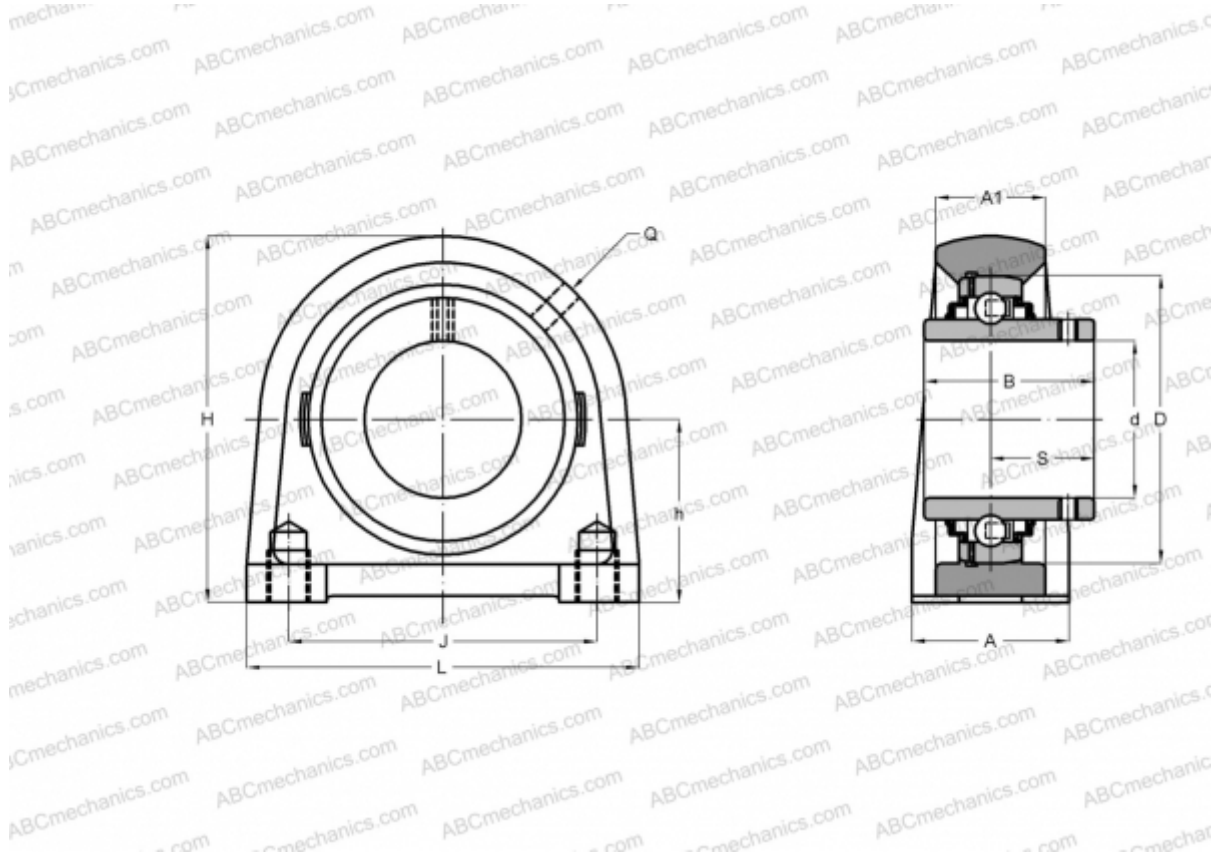

Technical specification

DIMENSIONS, MM

d	45,000
D	85,000
B	49,200
L	120,000
H	108,000
A	54,000
J	90,000
S	30,200
h	54,200

WEIGHT, KG

2,200

Bearing	UC 209
Housing	PA 209

MANUFACTURER

[ASAHI](#)