

UCEP 204 ASAHI

Ball bearing units

TYPE: Housing units, Plummer block, Cast iron housing, Radial insert ball bearing with grub screws in inner ring, Type UCEP (ASAHI)

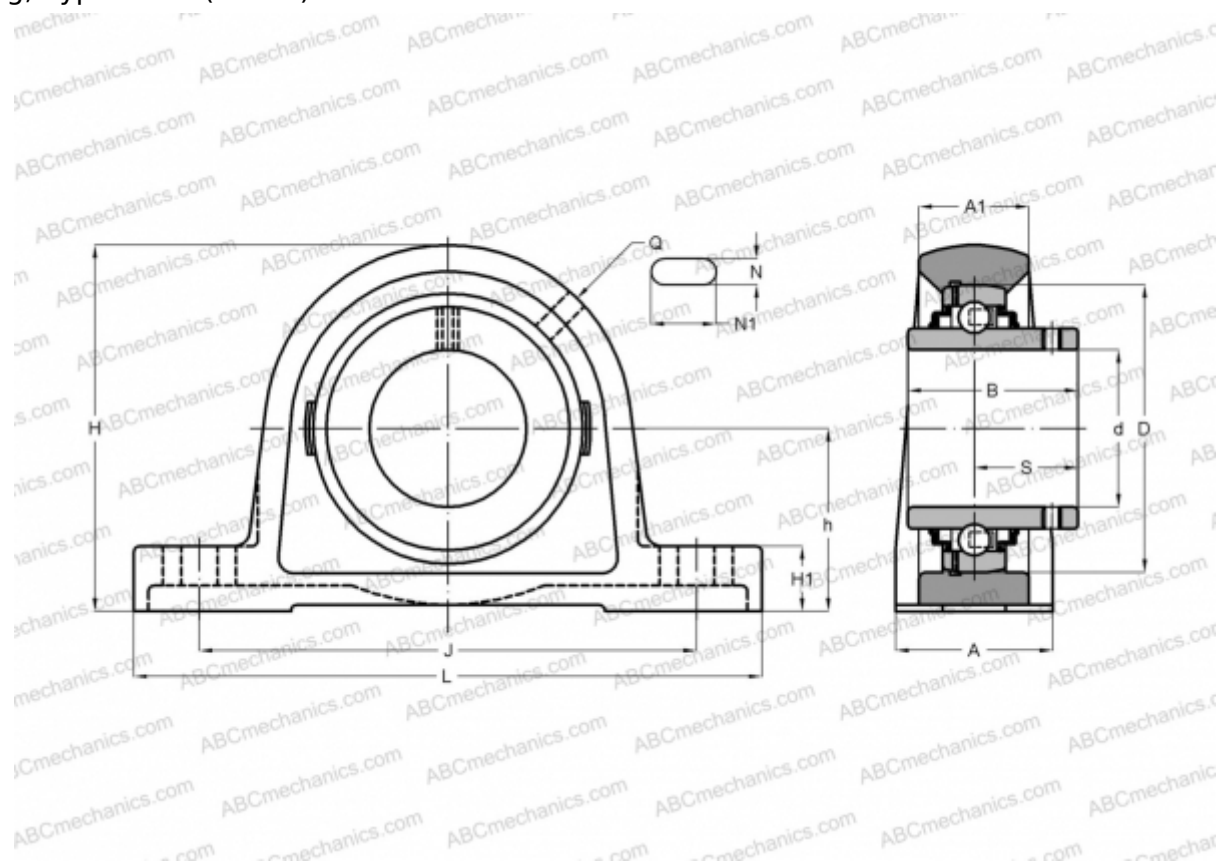

Technical specification

DIMENSIONS, MM

d	20,000
D	47,000
B	31,000
L	140,000
H	73,000
A	38,000
J	105,000
H1	16,000
N	13,000
N1	16,000
S	18,300
h	36,500

WEIGHT, KG

1,100

Bearing	UC 204
Housing	EP 204

MANUFACTURER

[ASAHI](#)