

BP 205 ASAHI

Ball bearing units

TYPE: Housing units, Plummer block, Cast iron housing, Radial insert ball bearing with grub screws in inner ring, Type BP (ASAHI)

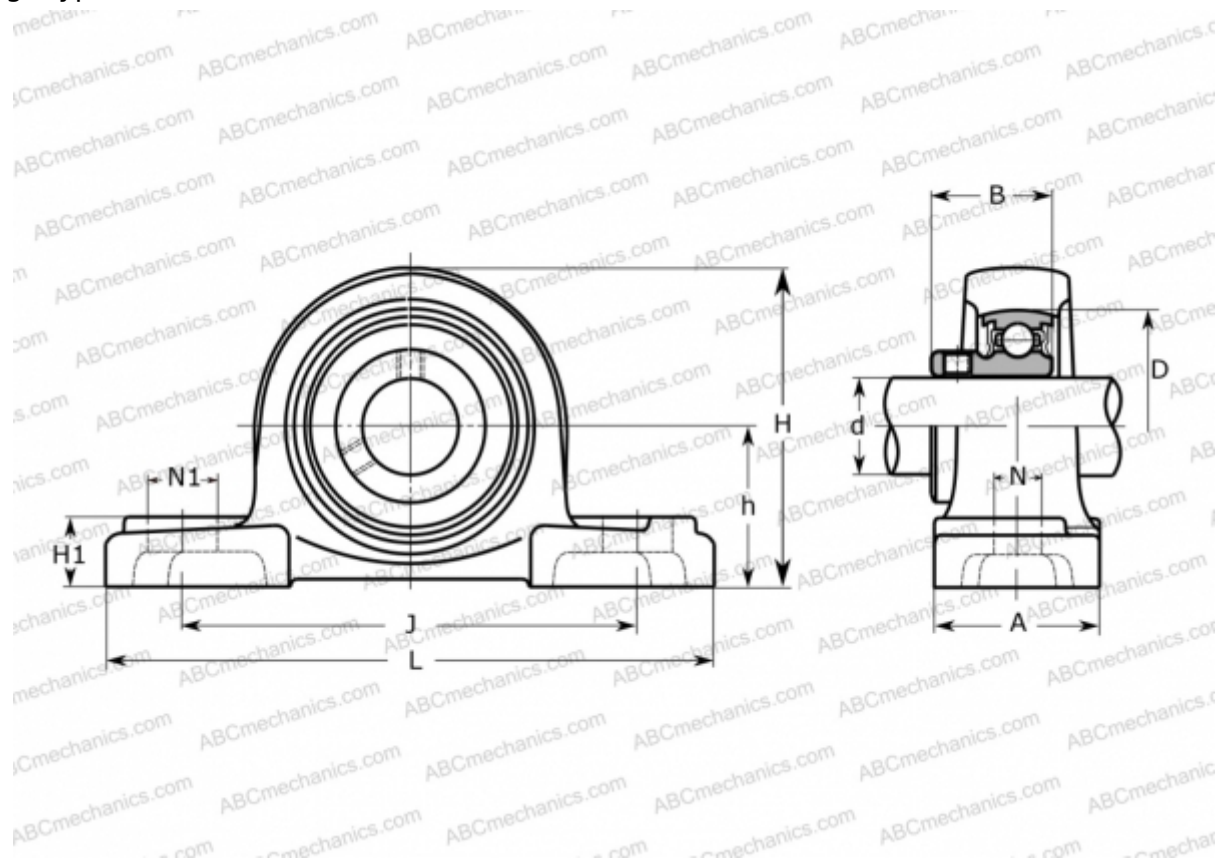

Technical specification

DIMENSIONS, MM

d	25,000
D	52,000
B	27,000
L	140,000
H	70,000
A	38,000
J	105,000
H1	16,000
N	13,000
N1	16,000
h	36,500

WEIGHT, KG

0,760

Bearing

B 5

Housing

P 205

MANUFACTURER

[ASAHI](http://www.asahi.com)