

BP 207 ASAHI

Ball bearing units

TYPE: Housing units, Plummer block, Cast iron housing, Radial insert ball bearing with grub screws in inner ring, Type BP (ASAHI)

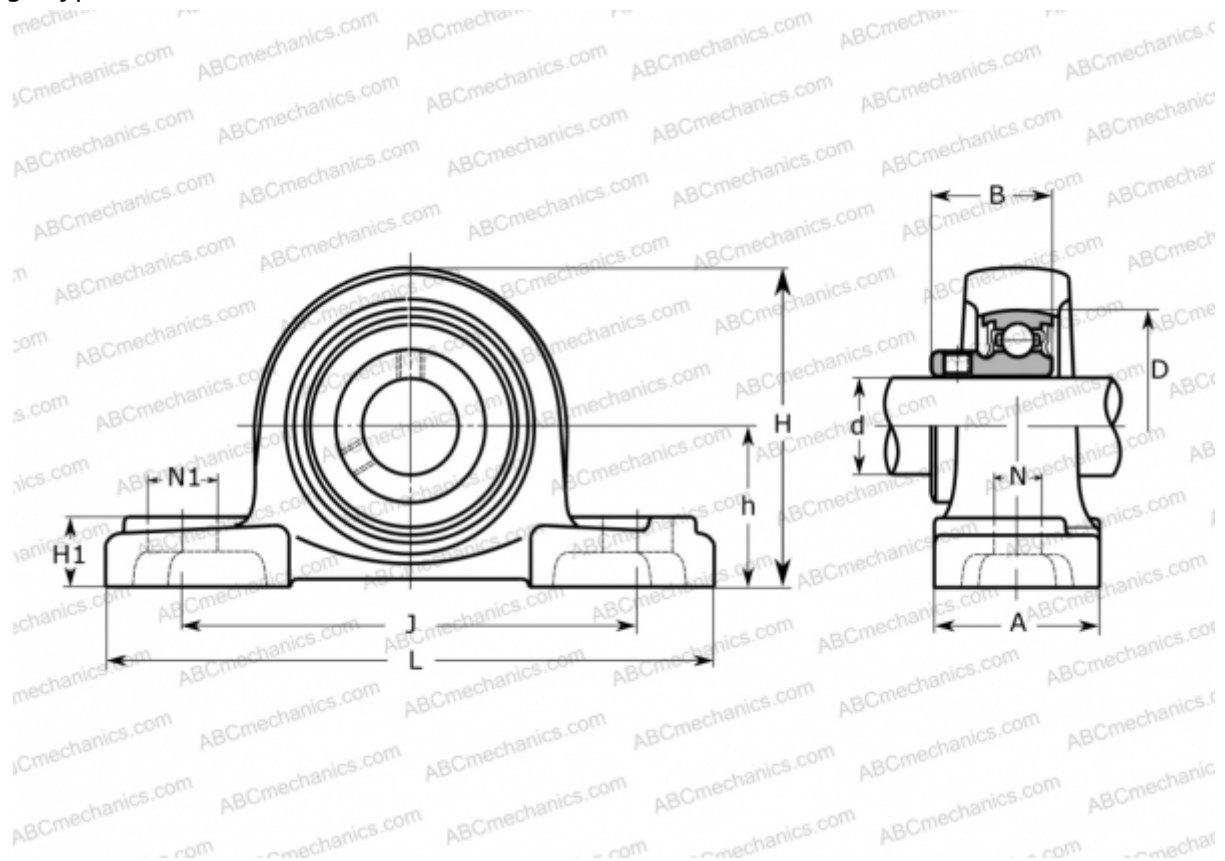

Technical specification

DIMENSIONS, MM

d	35,000
D	72,000
B	32,900
L	167,000
H	94,000
A	48,000
J	127,000
H1	19,000
N	17,000
N1	21,000
h	47,600

WEIGHT, KG

1,600

Bearing

B 7

Housing

P 207

MANUFACTURER

[ASAHI](http://www.asahi.com)