

BLLP 3J ASAHI

Ball bearing units

TYPE: Housing units, Plummer block, Cast iron housing, Radial insert ball bearing with grub screws in inner ring, Type BLLP (ASAHI)

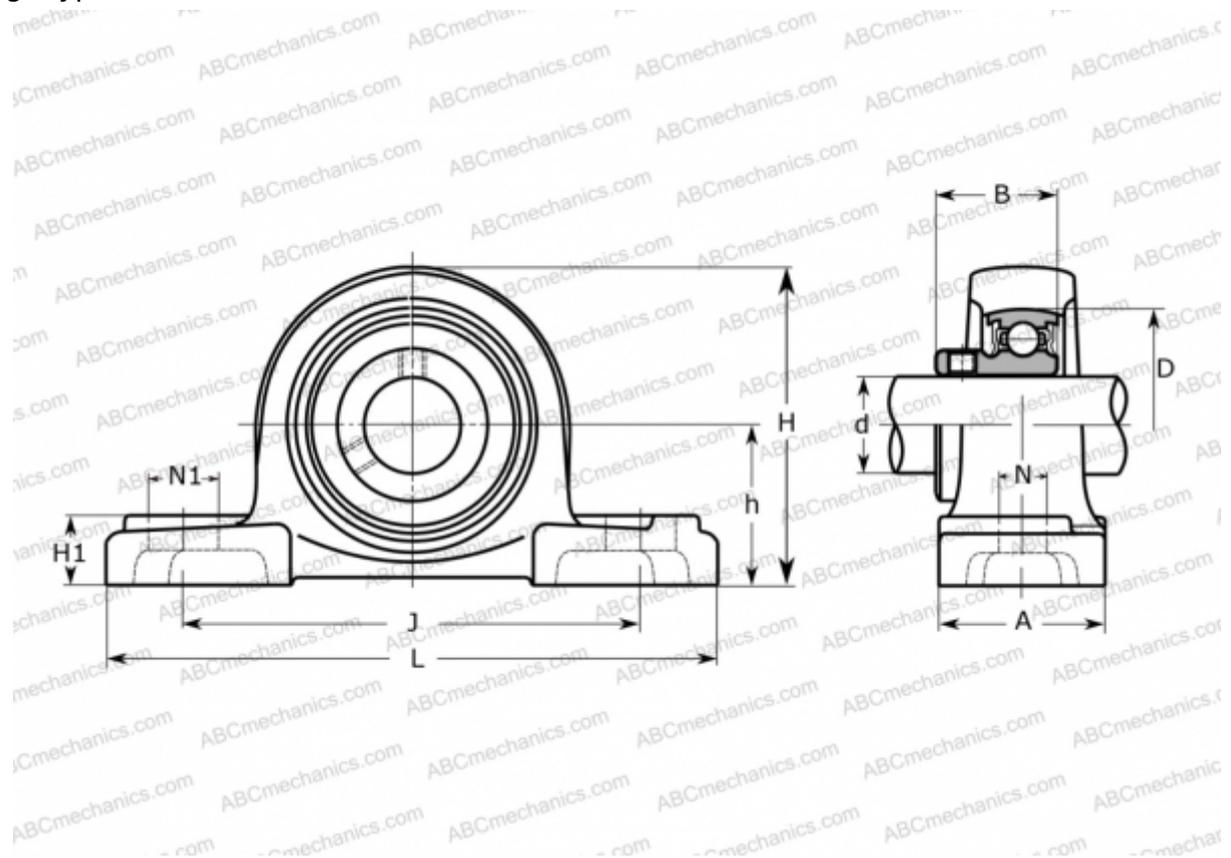

Technical specification

DIMENSIONS, MM

d	17,000
D	40,000
B	22,000
L	114,000
H	57,000
A	25,000
J	87,000
H1	12,000
N	12,000
N1	16,000
h	30,200

WEIGHT, KG

0,360

Bearing

B 3

Housing

LLP 3J

MANUFACTURER

[ASAHI](http://www.asahi.com)