

BLLP 4J ASAHI

Ball bearing units

TYPE: Housing units, Plummer block, Cast iron housing, Radial insert ball bearing with grub screws in inner ring, Type BLLP (ASAHI)

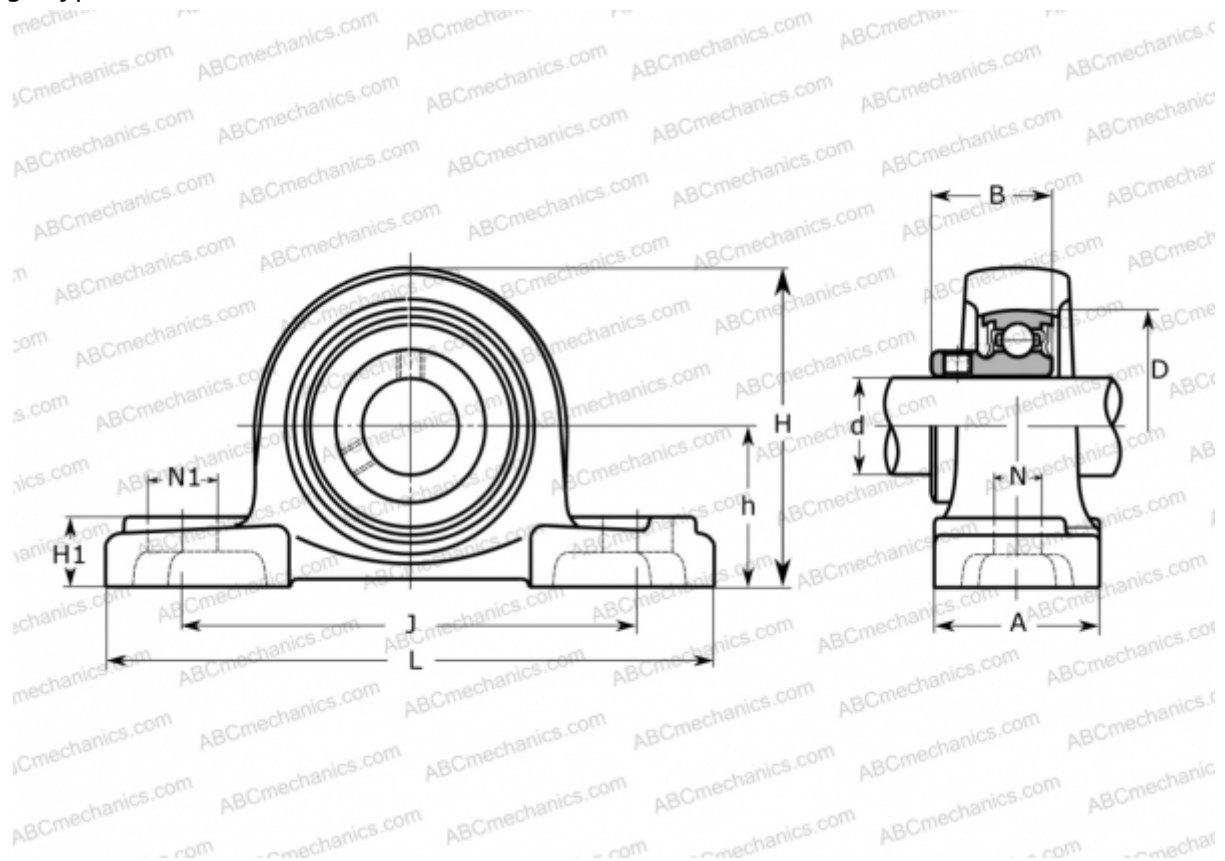

Technical specification

DIMENSIONS, MM

d	20,000
D	47,000
B	24,700
L	125,000
H	64,000
A	27,000
J	97,000
H1	13,000
N	12,000
N1	16,000
h	33,300

WEIGHT, KG

0,480

Bearing

B 4

Housing

LLP 4J

MANUFACTURER

[ASAHI](http://www.asahi.com)