

BLLP 5J ASAHI

Ball bearing units

TYPE: Housing units, Plummer block, Cast iron housing, Radial insert ball bearing with grub screws in inner ring, Type BLLP (ASAHI)

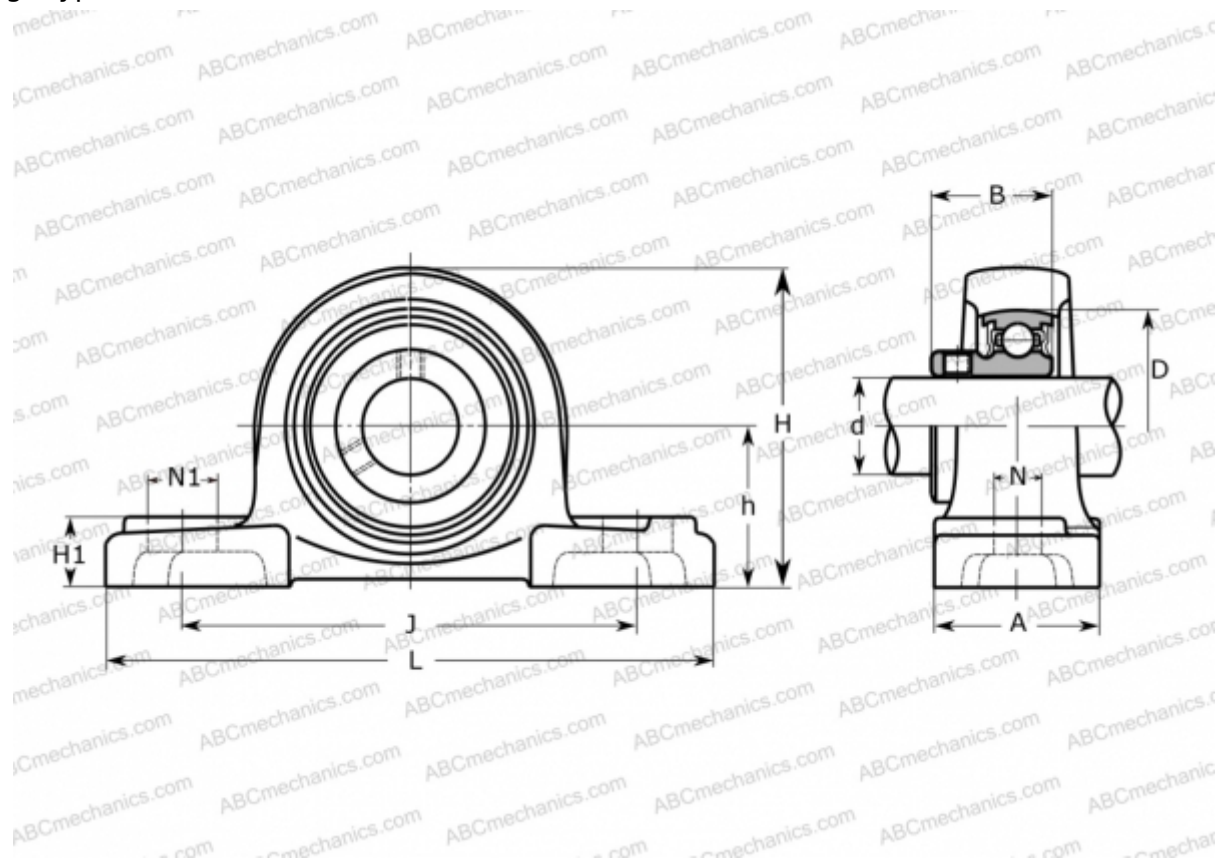

Technical specification

DIMENSIONS, MM

d	25,000
D	52,000
B	27,000
L	130,000
H	70,000
A	29,000
J	100,000
H1	13,000
N	12,000
N1	16,000
h	36,500

WEIGHT, KG

0,590

Bearing

B 5

Housing

LLP 5J

MANUFACTURER

[ASAHI](http://www.asahi.com)