

RASE75 INA

Ball bearing units

TYPE: Housing units, Plummer block, Cast iron housing, Radial insert ball bearing with eccentric locking collar, Type RASE (INA)

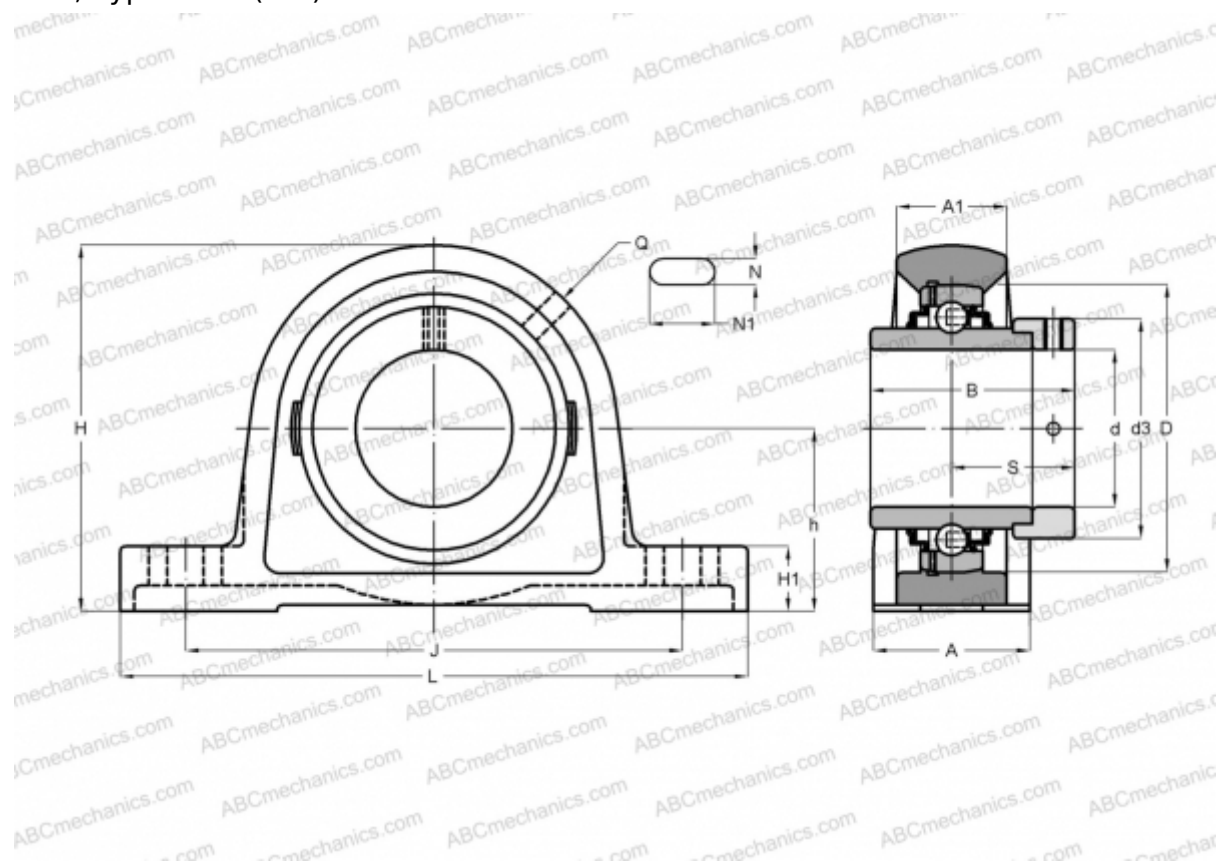

Technical specification

DIMENSIONS, MM

d	75,000
D	130,000
B	67,000
L	265,000
H	164,000
A	66,000
J	210,000
A1	48,000
H1	27,500
N	22,000
N1	30,000
S	45,600
d3	100,000
h	82,500
Q	Rp1/8

WEIGHT, KG

6,580

Bearing

GE75-KRR-B

Housing

GG.ASE15

MANUFACTURER

[INA](#)

CALCULATION DATA

Basic dynamic load rating, C	62,000 kN
Basic static load rating, Co	44,500 kN