

## LASE25-N INA

Ball bearing units

TYPE: Housing units, Plummer block, Cast iron housing, Radial insert ball bearing with eccentric locking collar, Type LASE (INA)

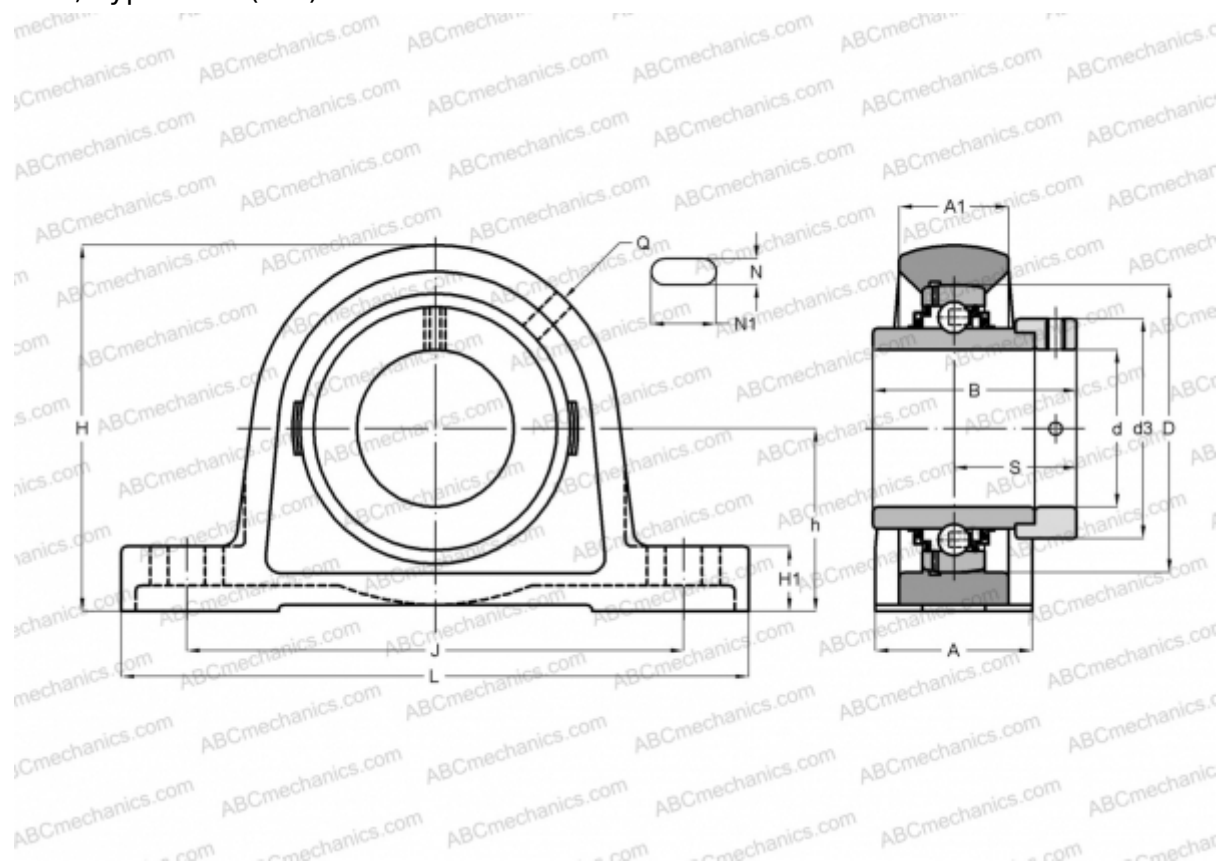

### Technical specification

#### DIMENSIONS, MM

d	25,000
D	52,000
B	44,500
L	130,000
H	70,000
A	36,000
J	103,000
A1	21,000
H1	14,500
N	11,000
N1	19,000
S	27,000
d3	37,500
h	36,500
Q	Rp1/8

Bearing	GE25-KLL-B
Housing	GG.ASE05-N
Protective cover	KASK05

#### MANUFACTURER

[INA](#)

#### CALCULATION DATA

Basic dynamic load rating, C	14,000 kN
Basic static load rating, Co	7,800 kN