

RSAO30 INA

Ball bearing units

TYPE: Housing units, Plummer block, Cast iron housing, Radial insert ball bearing with eccentric locking collar, Type RSAO (INA)

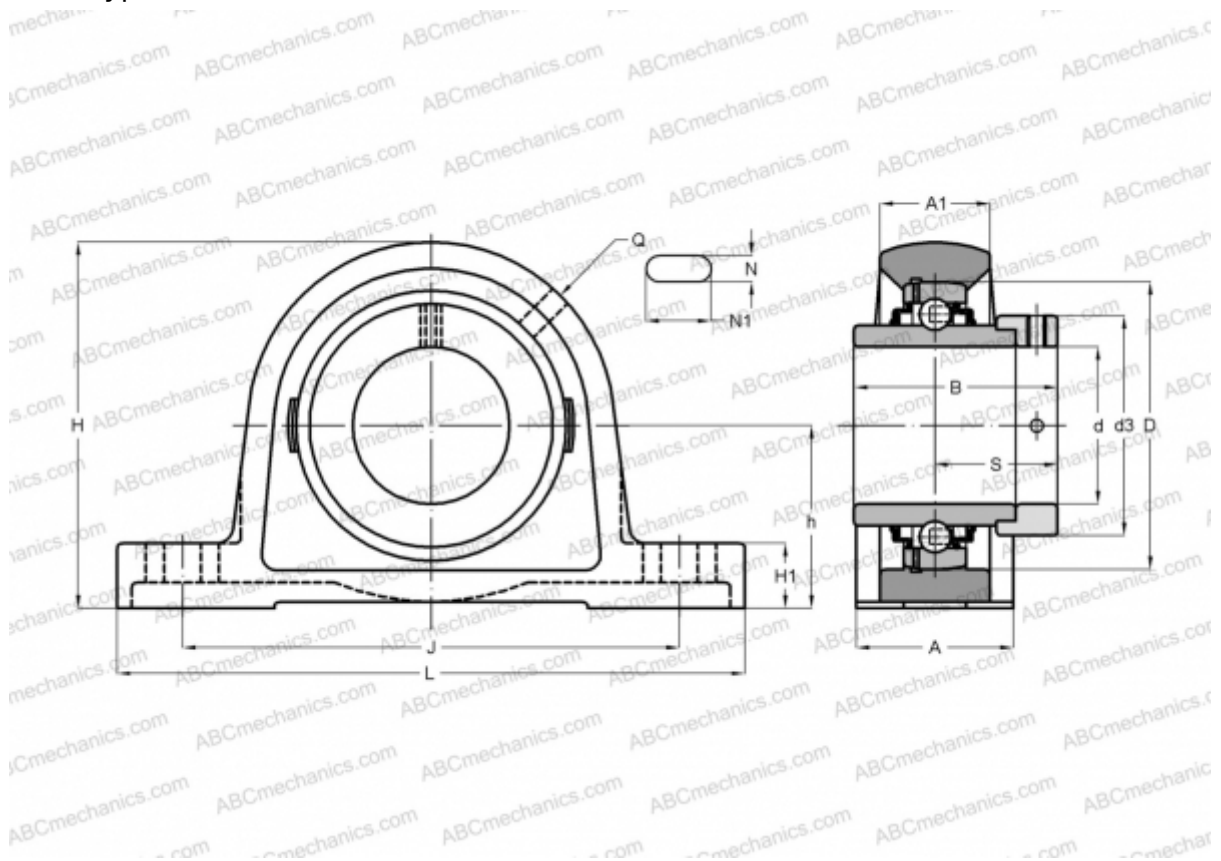

Technical specification

DIMENSIONS, MM

d	30,000
D	72,000
B	50,000
L	180,000
H	95,000
A	50,000
J	140,000
A1	28,000
H1	18,000
N	17,500
N1	20,500
S	32,500
d3	51,000
h	50,000
Q	Rp1/8

WEIGHT, KG

	1,800
Bearing	GNE30-KRR-B
Housing	GG.SAO06

MANUFACTURER

[INA](#)

CALCULATION DATA

Basic dynamic load rating, C	29,500 kN
Basic static load rating, Co	16,700 kN