

## RSAO40 INA

Ball bearing units

TYPE: Housing units, Plummer block, Cast iron housing, Radial insert ball bearing with eccentric locking collar, Type RSAO (INA)

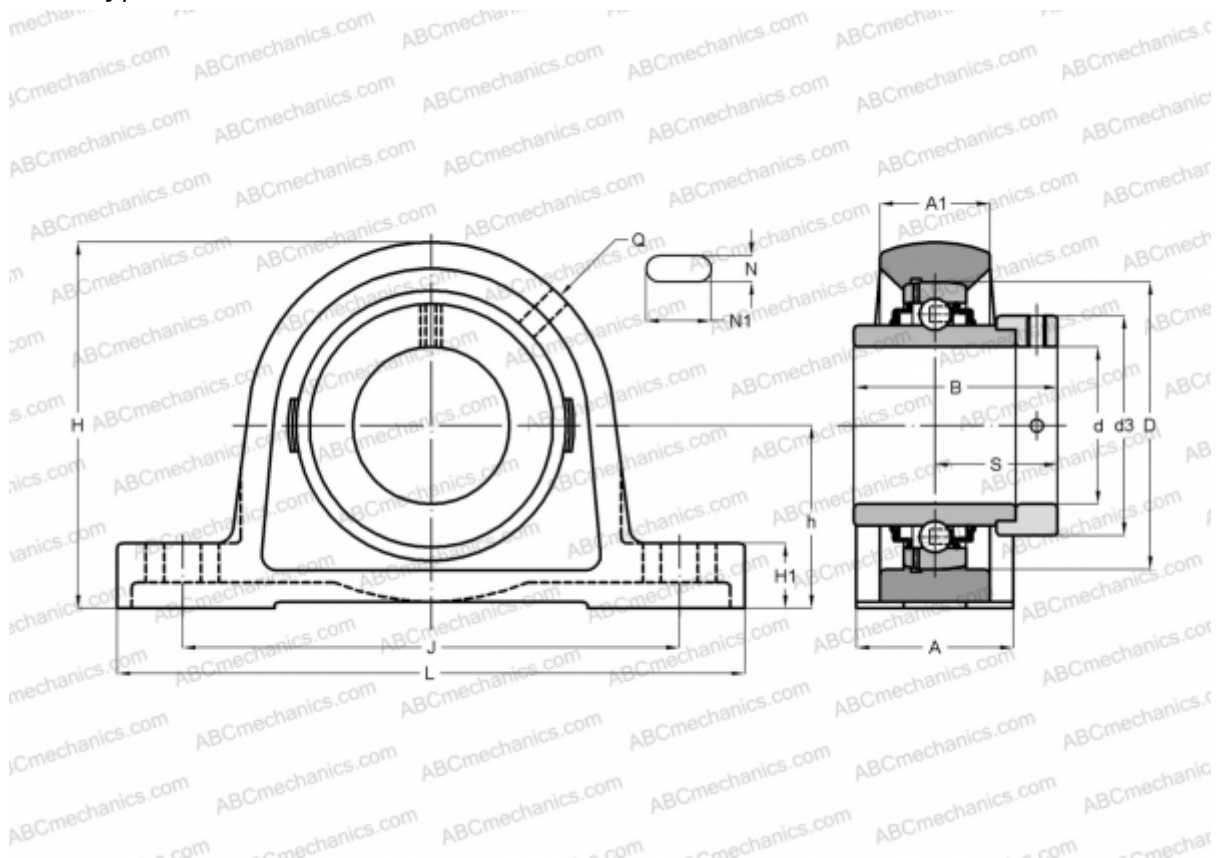

### Technical specification

#### DIMENSIONS, MM

d	40,000
D	90,000
B	54,600
L	220,000
H	116,000
A	60,000
J	170,000
A1	31,000
H1	22,000
N	17,500
N1	27,500
S	36,600
d3	63,000
h	60,000
Q	Rp1/8

#### WEIGHT, KG

	3,180
Bearing	GNE40-KRR-B
Housing	GG.SAO08

#### MANUFACTURER

[INA](#)

#### CALCULATION DATA

Basic dynamic load rating, C	44,500 kN
Basic static load rating, Co	26,000 kN