

## RSAO80 INA

Ball bearing units

TYPE: Housing units, Plummer block, Cast iron housing, Radial insert ball bearing with eccentric locking collar, Type RSAO (INA)

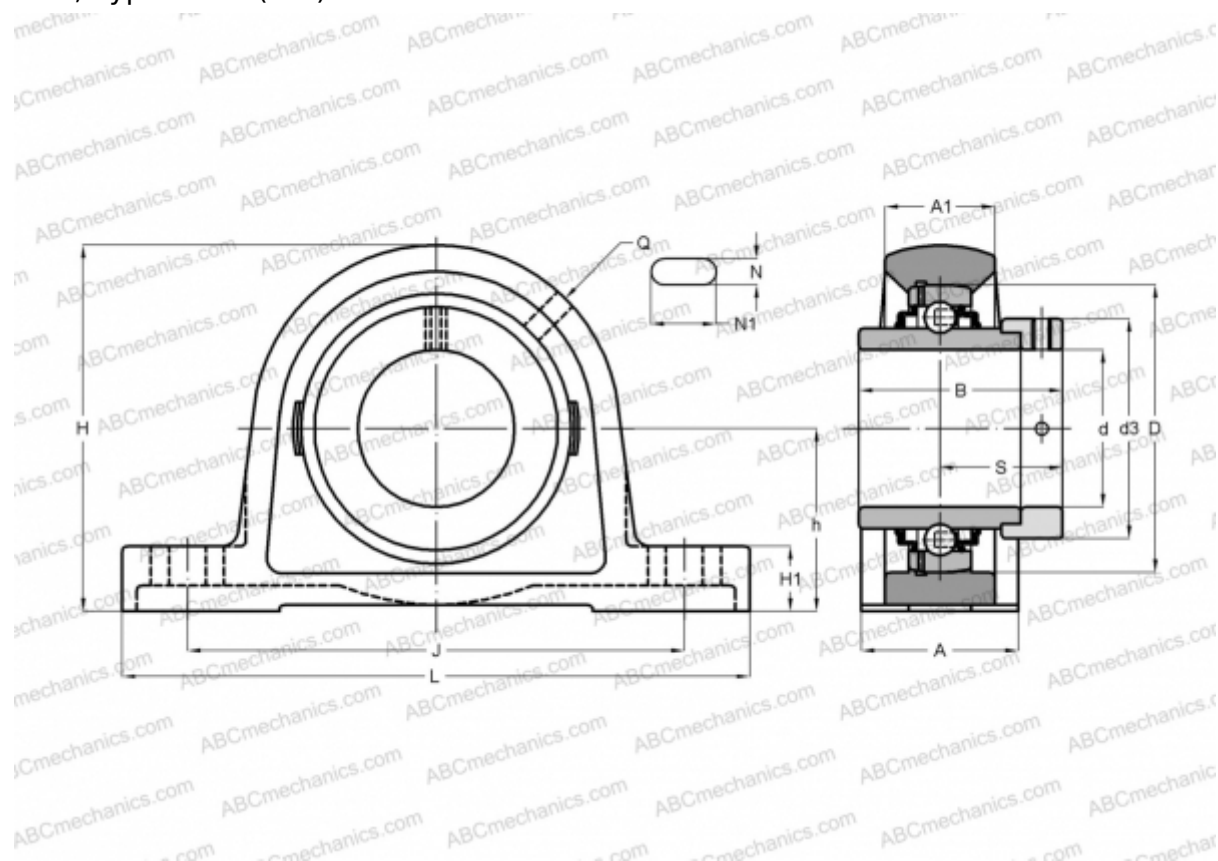

### Technical specification

#### DIMENSIONS, MM

d	80,000
D	170,000
B	93,600
L	390,000
H	226,000
A	110,000
J	315,000
A1	76,000
H1	50,000
N	25,500
N1	44,500
S	59,700
d3	118,000
h	116,000
Q	Rp1/8

#### WEIGHT, KG

22,500

Bearing

GNE80-KRR-B

Housing

GG.SAO16

#### MANUFACTURER

[INA](#)

#### CALCULATION DATA

Basic dynamic load rating, C	123,000 kN
Basic static load rating, Co	87,000 kN