

RASEL30-N INA

Ball bearing units

TYPE: Housing units, Plummer block, Cast iron housing, Non-locating bearing, drive slot on inner ring, Type RASEL (INA)

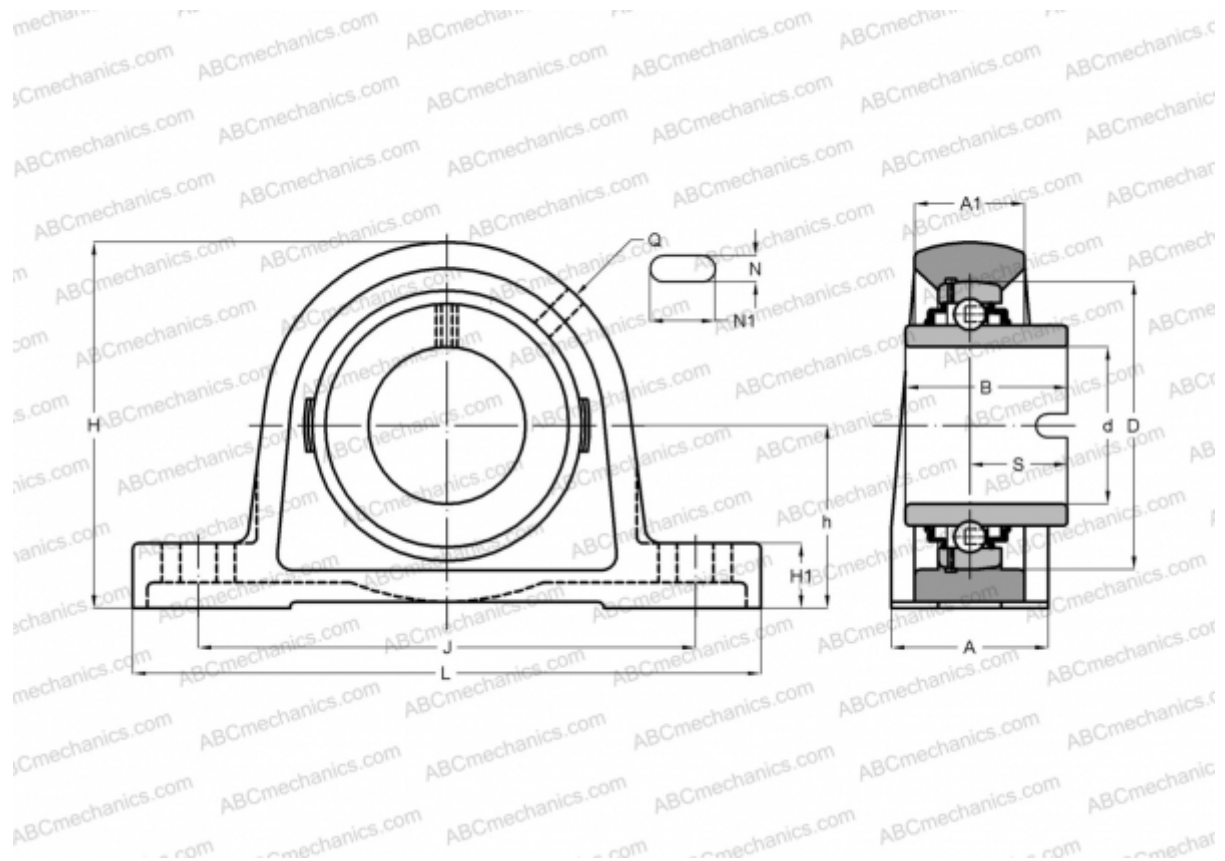

Technical specification

DIMENSIONS, MM

d	30,000
D	62,000
B	36,500
L	158,000
H	82,000
A	40,000
J	118,000
A1	25,000
H1	17,000
N	14,000
N1	22,000
S	22,000
h	42,900
Q	Rp1/8

WEIGHT, KG

	1,100
Bearing	GLE30-KRR-B
Housing	GG.ASE06-N
Protective cover	KASK06

MANUFACTURER

[INA](#)

CALCULATION DATA

Basic dynamic load rating, C	19,500 kN
Basic static load rating, Co	11,300 kN