

RSHE40-N INA

Ball bearing units

TYPE: Housing units, Plummer block, Narrow cast iron housing, Radial insert ball bearing with eccentric locking collar, Type RSHE (INA)

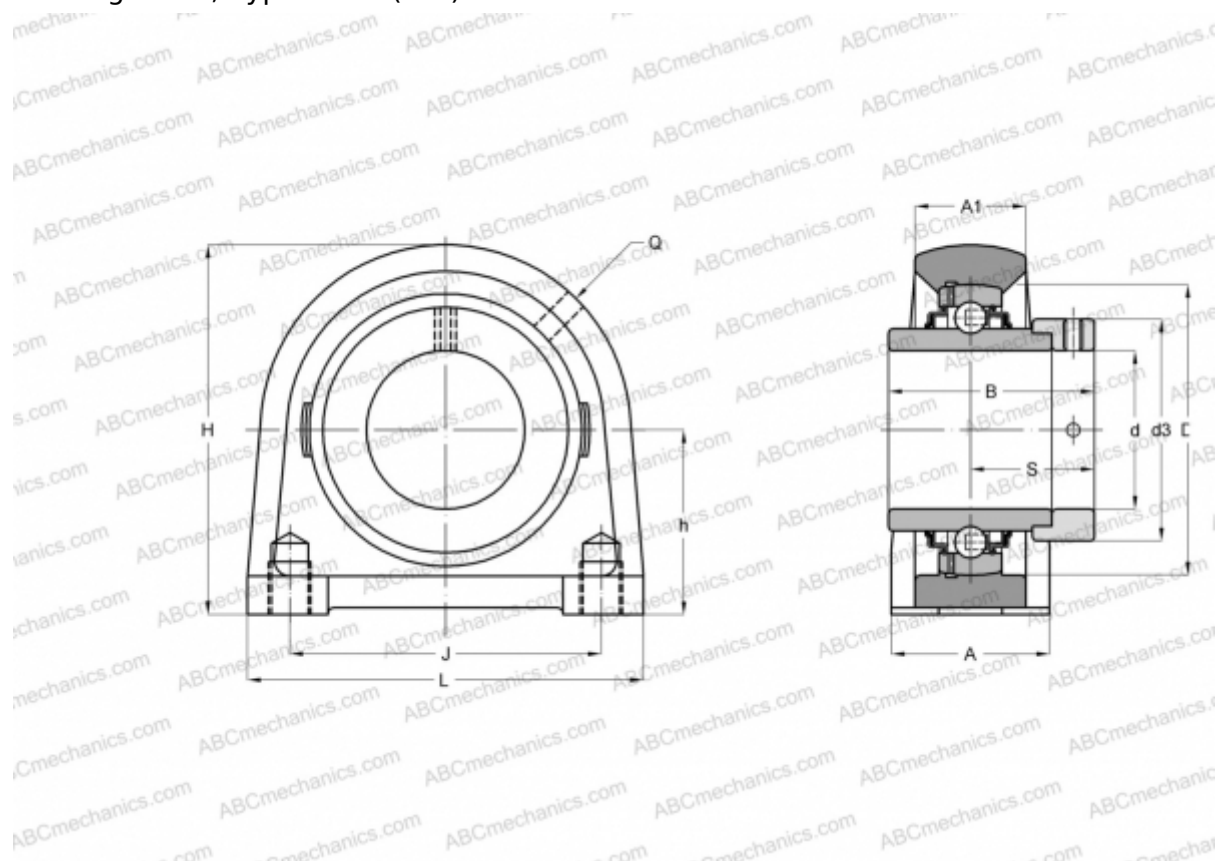

Technical specification

DIMENSIONS, MM

d	40,000
D	80,000
B	56,500
L	116,000
H	99,000
A	48,000
J	88,900
A1	30,000
S	35,100
d3	58,000
h	49,200
Q	Rp1/8

WEIGHT, KG 1,960

Bearing	GE40-KRR-B
Housing	GG.SHE08-E-N
Protective cover	KASK08

MANUFACTURER

[INA](#)

CALCULATION DATA

Basic dynamic load rating, C	32,500 kN
Basic static load rating, Co	19,800 kN