

TSHE25-N INA

Ball bearing units

TYPE: Housing units, Plummer block, Narrow cast iron housing, Radial insert ball bearing with eccentric locking collar, Type TSHE (INA)

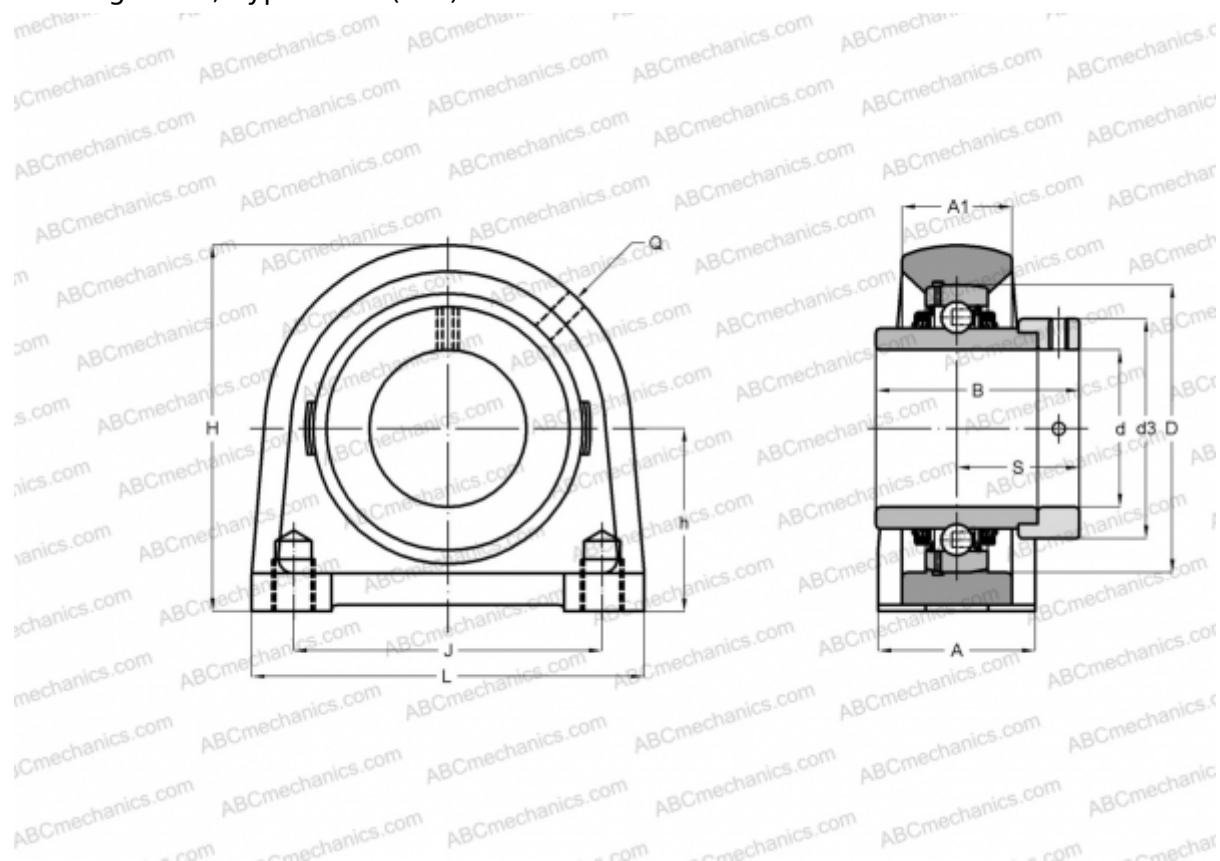

Technical specification

DIMENSIONS, MM

d	25,000
D	52,000
B	44,500
L	70,000
H	70,000
A	36,000
J	50,800
A1	21,000
S	27,000
d3	37,500
h	36,500
Q	Rp1/8

WEIGHT, KG 0,660

Bearing	GE25-KTT-B
Housing	GG.SHE05-E-N
Protective cover	KASK05

MANUFACTURER

[INA](#)

CALCULATION DATA

Basic dynamic load rating, C	14,000 kN
Basic static load rating, Co	7,800 kN