

TSHE50-N INA

Ball bearing units

TYPE: Housing units, Plummer block, Narrow cast iron housing, Radial insert ball bearing with eccentric locking collar, Type TSHE (INA)

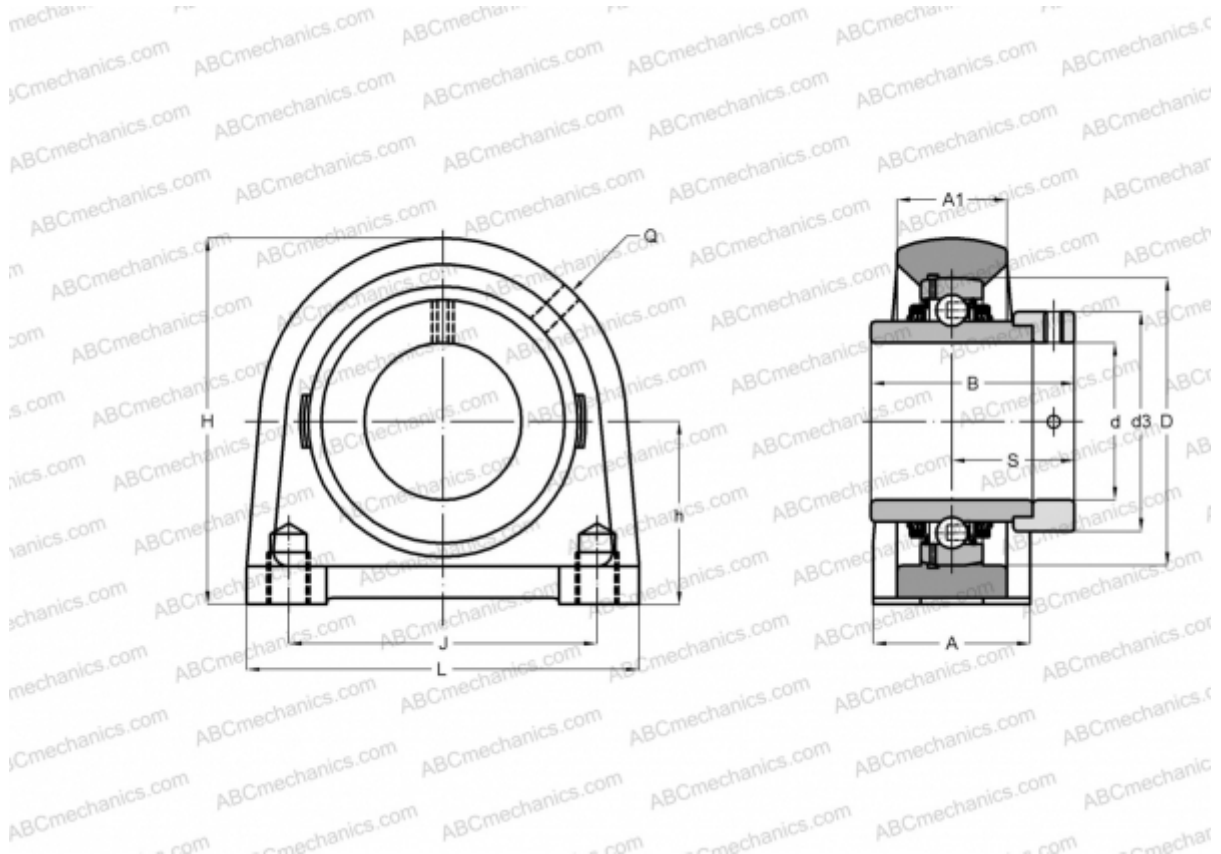

Technical specification

DIMENSIONS, MM

d	50,000
D	90,000
B	62,800
L	135,000
H	115,000
A	54,000
J	101,600
A1	34,000
S	38,200
d3	69,000
h	57,200
Q	Rp1/8

WEIGHT, KG 2,470

Bearing	GE50-KTT-B
Housing	GG.SHE10-E-N
Protective cover	KASK10

MANUFACTURER

[INA](#)

CALCULATION DATA

Basic dynamic load rating, C	35,000 kN
Basic static load rating, Co	23,200 kN