

RSHEY45 INA

Ball bearing units

TYPE: Housing units, Plummer block, Narrow cast iron housing, Radial insert ball bearing with grub screws in inner ring, Type RSHEY (INA)

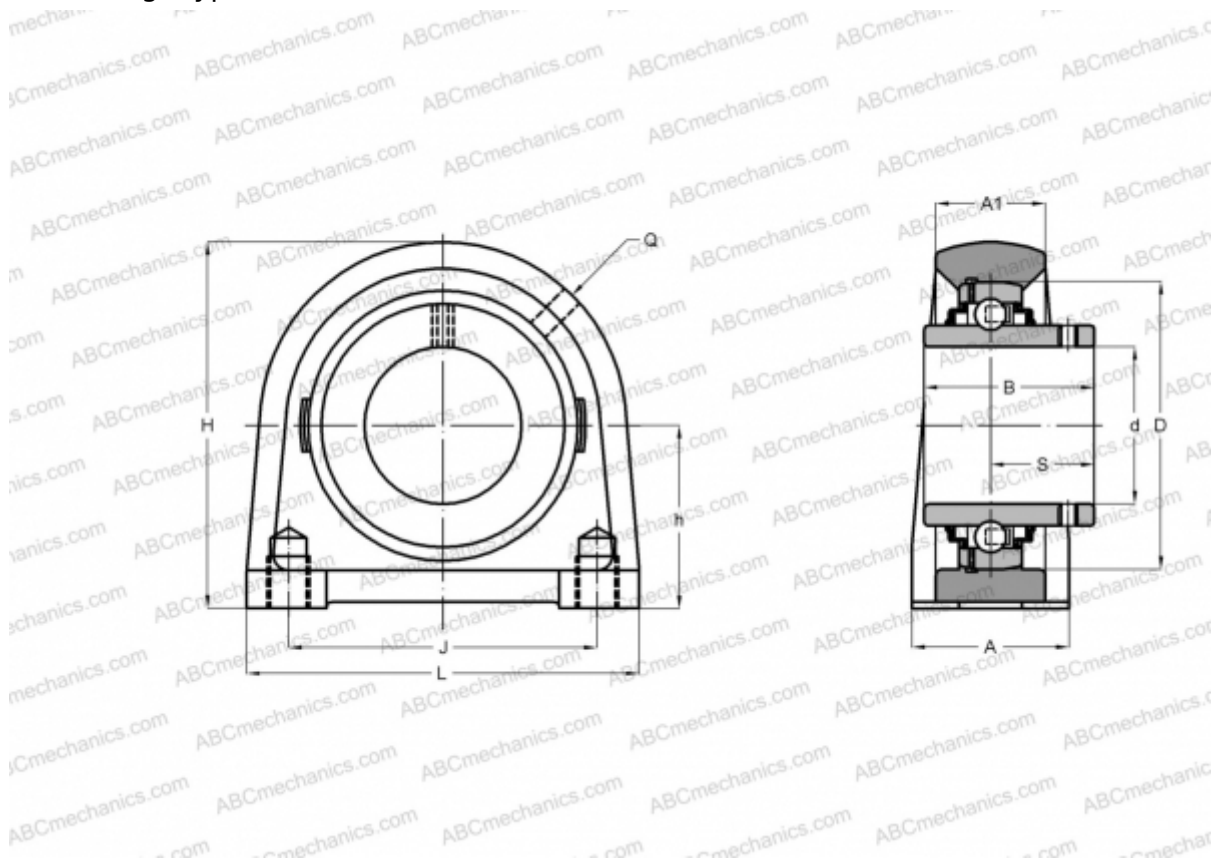

Technical specification

DIMENSIONS, MM

d	45,000
D	85,000
B	49,200
L	120,000
H	107,000
A	48,000
J	95,300
A1	32,000
S	30,500
h	54,000
Q	Rp1/8

WEIGHT, KG

2,150

Bearing

GYE45-KRR-B

Housing

GG.SHE09

MANUFACTURER

[INA](#)

CALCULATION DATA

Basic dynamic load rating, C	32,500 kN
Basic static load rating, Co	20,400 kN