

## PBS15 INA

Ball bearing units

TYPE: Housing units, Plummer block, Sheet steel housing, Radial insert ball bearing with eccentric locking collar, Type PBS (INA)

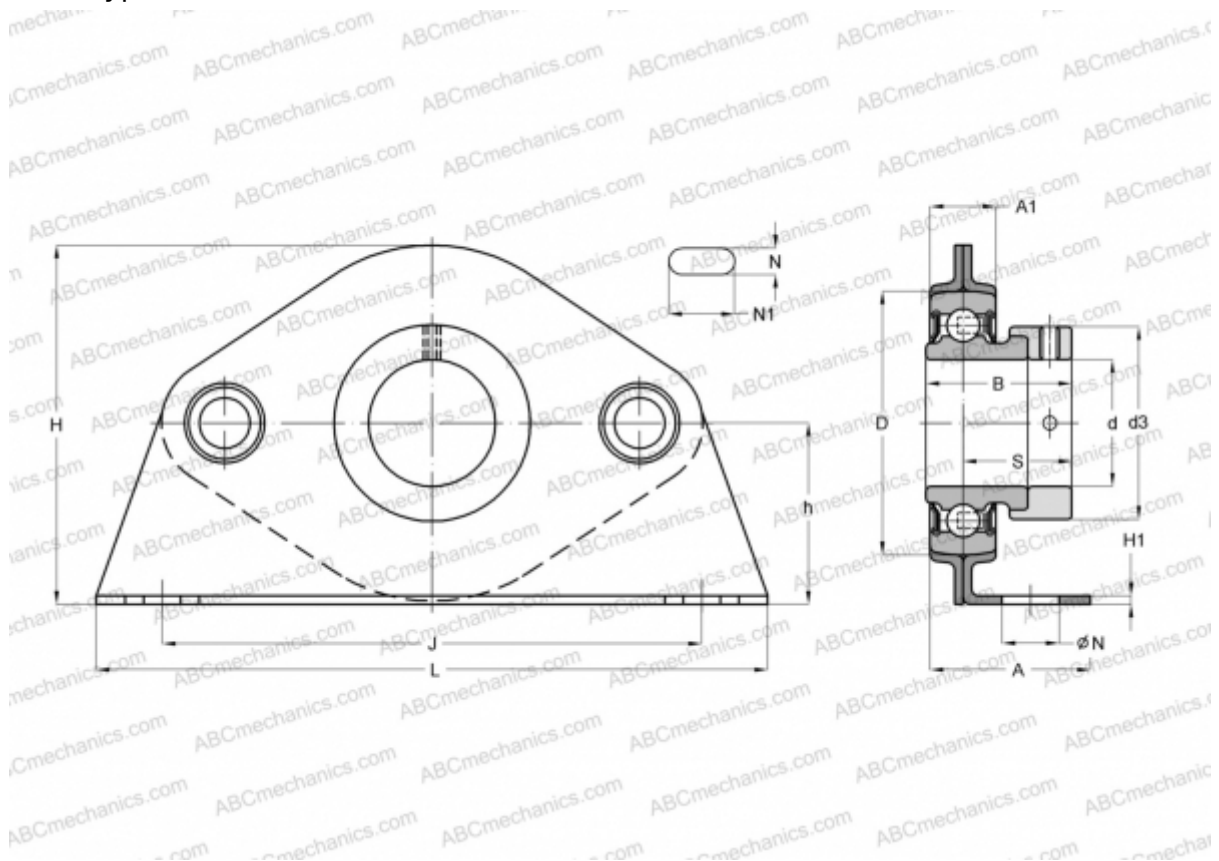

### Technical specification

#### DIMENSIONS, MM

d	15,000
D	40,000
B	28,600
L	123,800
H	59,600
A	32,500
J	92,000
A1	14,200
H1	2,600
N	10,500
N1	5,600
S	22,100
d3	28,000
h	30,200

#### WEIGHT, KG

Bearing	0,320
Housing	RAE15-NPP-B GEH40-PBS

#### MANUFACTURER

[INA](#)

#### CALCULATION DATA

Basic dynamic load rating, C	9,800 kN
Basic static load rating, Co	4,750 kN