

PB15 INA

Ball bearing units

TYPE: Housing units, Plummer block, Sheet steel housing, Radial insert ball bearing with eccentric locking collar, Type PB (INA)

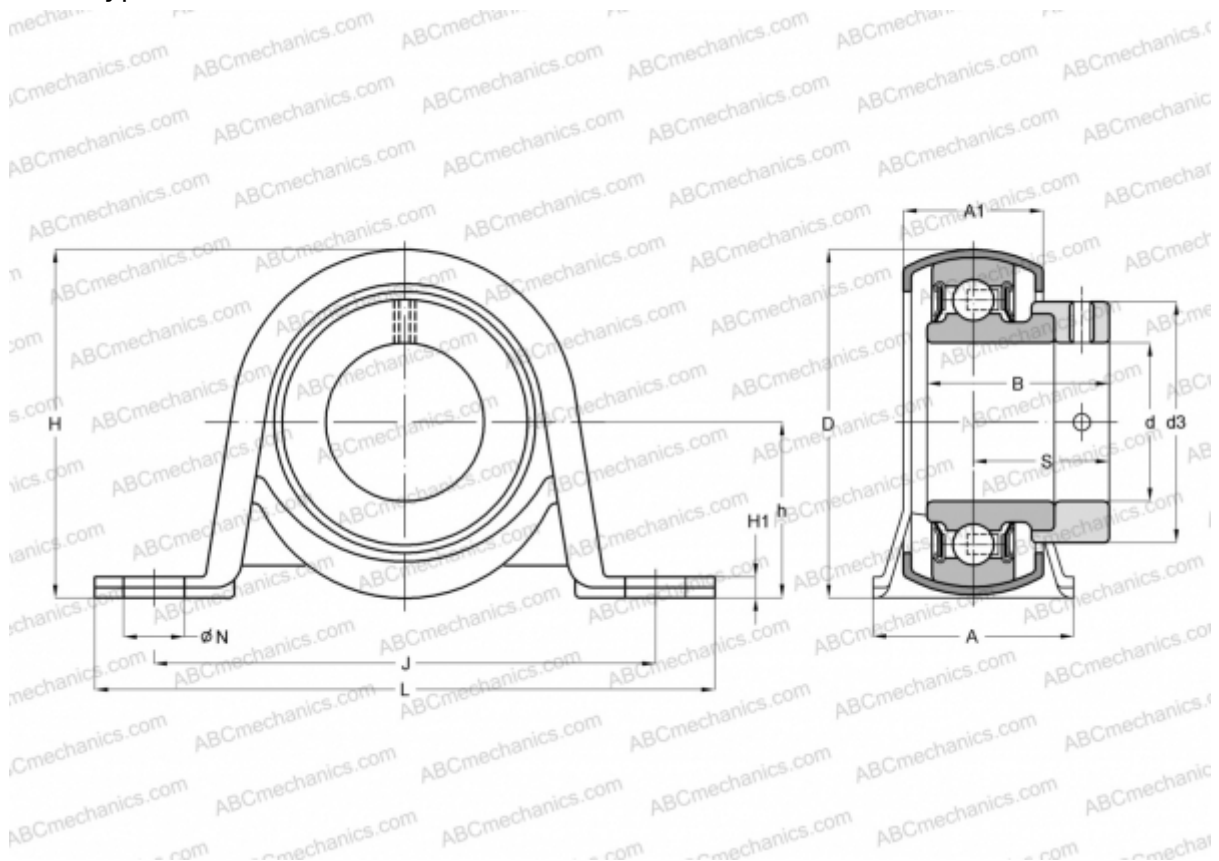

Technical specification

DIMENSIONS, MM

d	15,000
D	40,000
B	28,600
L	85,700
H	43,200
A	25,400
J	68,000
A1	18,400
H1	2,600
N	9,500
S	22,100
d3	28,000
h	22,200

Bearing	RAE15-NPP-B
Housing	GEH40-BT

MANUFACTURER

[INA](#)

CALCULATION DATA

Basic dynamic load rating, C	9,800 kN
Basic static load rating, Co	4,750 kN

WEIGHT, KG 0,170