

PB20 INA

Ball bearing units

TYPE: Housing units, Plummer block, Sheet steel housing, Radial insert ball bearing with eccentric locking collar, Type PB (INA)

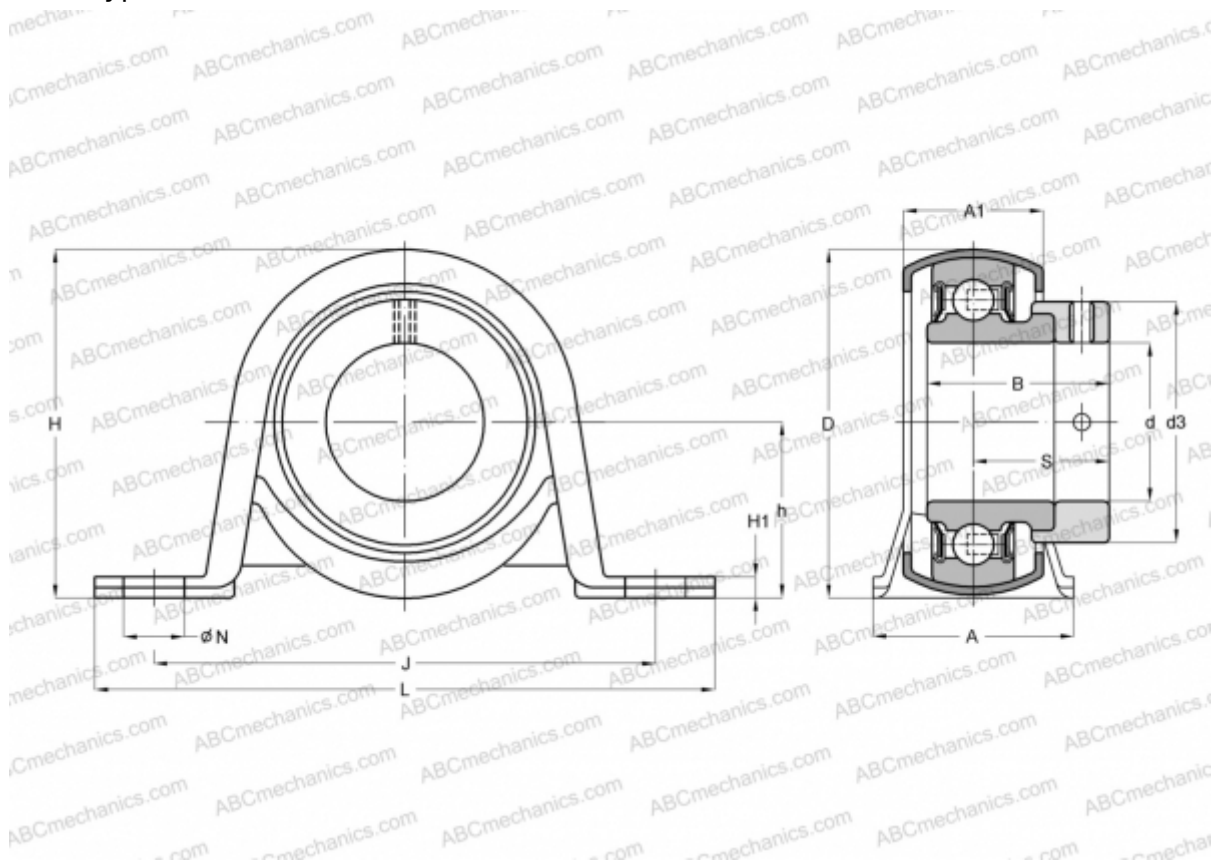

Technical specification

DIMENSIONS, MM

d	20,000
D	47,000
B	31,000
L	98,400
H	50,100
A	31,800
J	76,000
A1	22,300
H1	3,300
N	9,500
S	23,500
d3	33,000
h	25,400

Bearing	RAE20-NPP-B
Housing	GEH47-BT

MANUFACTURER

[INA](#)

CALCULATION DATA

Basic dynamic load rating, C	12,800 kN
Basic static load rating, Co	6,600 kN

WEIGHT, KG 0,270