

## RCJT50-N INA

Ball bearing units

TYPE: Housing units, Two-bolt flanged housing units, Cast iron housing, Radial insert ball bearing with eccentric locking collar, Type RCJT (INA)

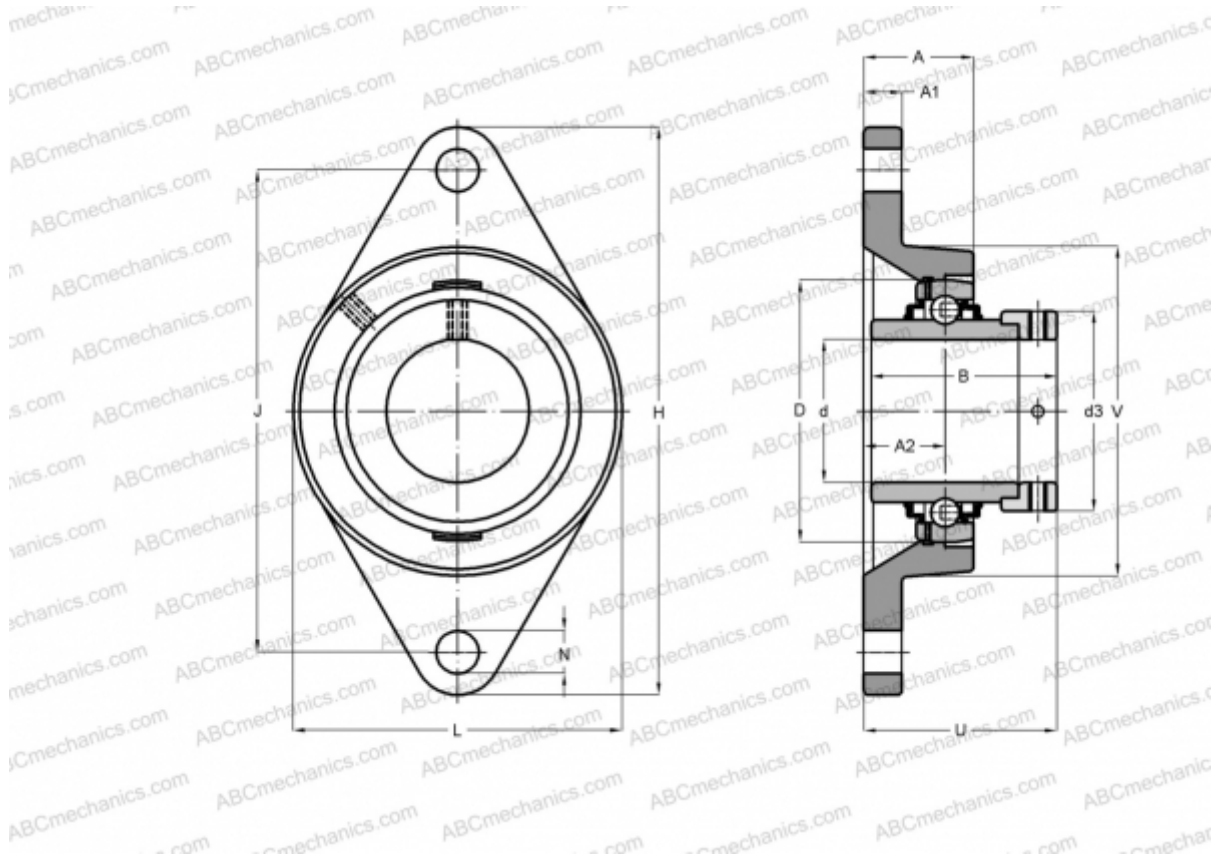

### Technical specification

#### DIMENSIONS, MM

d	50,000
D	90,000
B	62,800
L	116,000
H	190,000
A	39,000
J	157,000
A1	13,000
A2	28,000
N	18,000
d3	69,000
U	66,200
V	116,000
Q	Rp1/8

#### WEIGHT, KG

	2,200
Bearing	GE50-KRR-B
Housing	GG.CJT10-N
Protective cover	KASK10

#### MANUFACTURER

[INA](#)

#### CALCULATION DATA

Basic dynamic load rating, C	35,000 kN
Basic static load rating, Co	23,200 kN