

RCJT75 INA

Ball bearing units

TYPE: Housing units, Two-bolt flanged housing units, Cast iron housing, Radial insert ball bearing with eccentric locking collar, Type RCJT (INA)

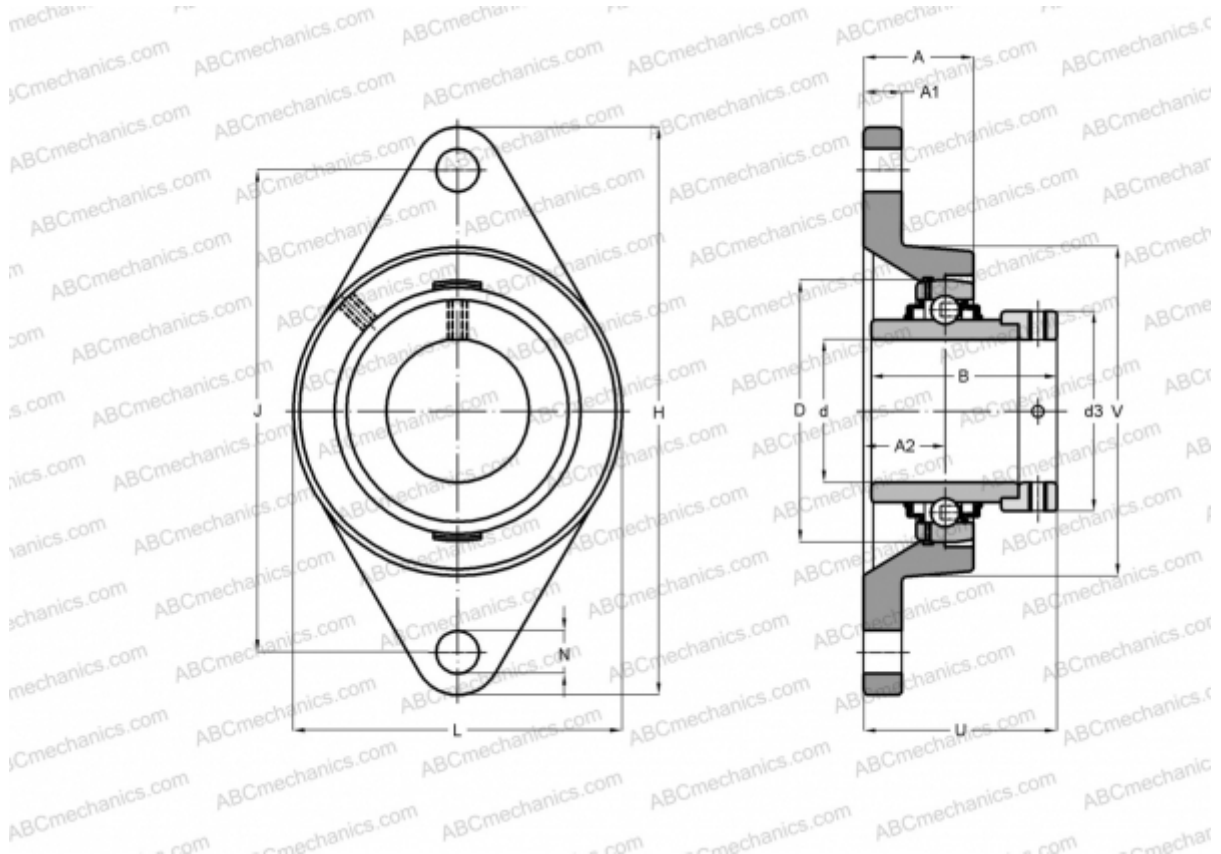

Technical specification

DIMENSIONS, MM

d	75,000
D	130,000
B	67,000
L	160,000
H	258,000
A	57,000
J	216,000
A1	18,000
A2	38,000
N	21,000
d3	100,000
U	83,600
V	160,000
Q	Rp1/8

WEIGHT, KG

	6,000
Bearing	GE75-KRR-B
Housing	GG.CJT15

MANUFACTURER

[INA](#)

CALCULATION DATA

Basic dynamic load rating, C	62,000 kN
Basic static load rating, Co	44,500 kN