

## RCJT35-FA164 INA

Ball bearing units

TYPE: Housing units, Two-bolt flanged housing units, Cast iron housing, Radial insert ball bearing with eccentric locking collar, Type RCJT (INA), for high temperatures (+250)

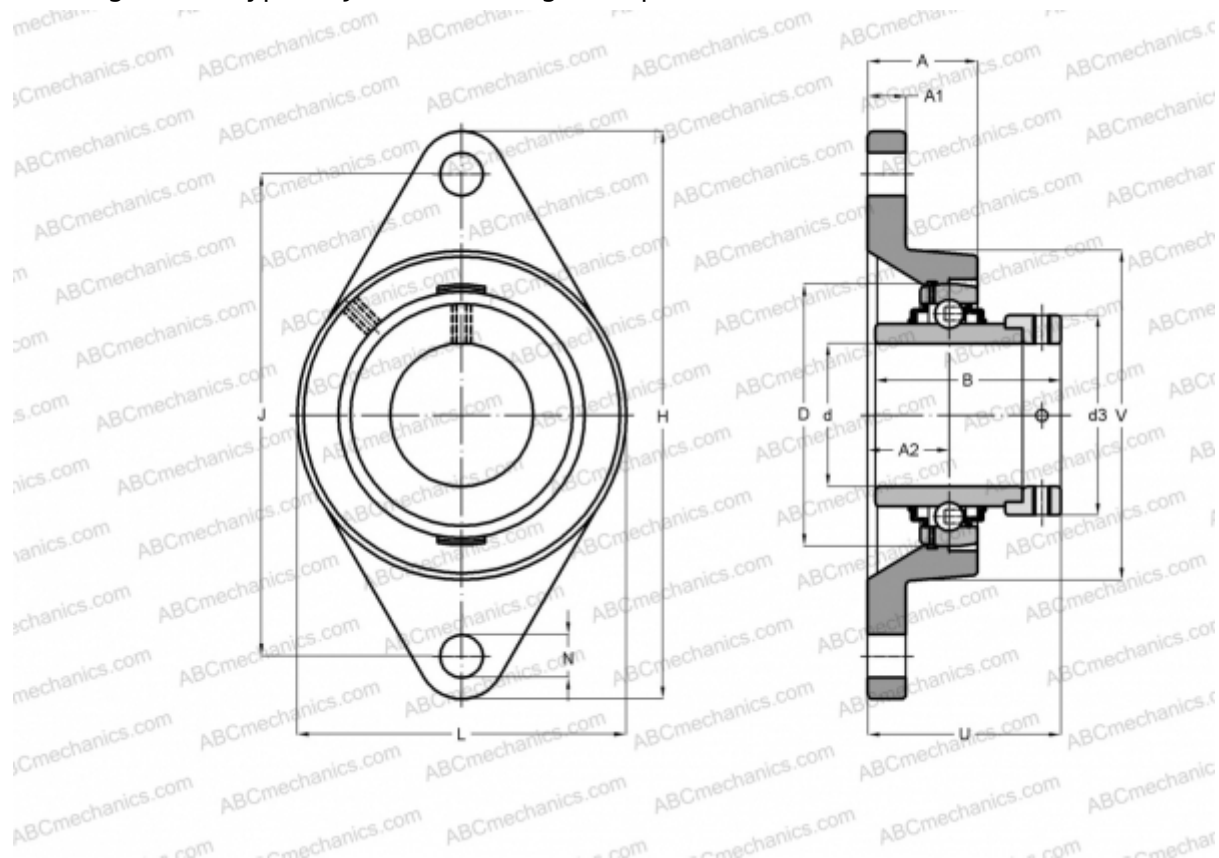

### Technical specification

#### DIMENSIONS, MM

d	35,000
D	72,000
B	51,300
L	92,000
H	155,000
A	30,500
J	130,000
A1	12,500
A2	21,000
N	14,000
d3	51,000
U	53,500
V	92,000
Q	Rp1/8

#### WEIGHT, KG

	1,190
Bearing	GE35-KRR-B-
Housing	GG.CJT07-N

#### MANUFACTURER

[INA](#)

#### CALCULATION DATA

Basic dynamic load rating, C	25,500 kN
Basic static load rating, Co	15,300 kN
Operating temperature max	250 °C