

TCJT45 INA

Ball bearing units

TYPE: Housing units, Two-bolt flanged housing units, Cast iron housing, Radial insert ball bearing with eccentric locking collar, Type TCJT (INA)

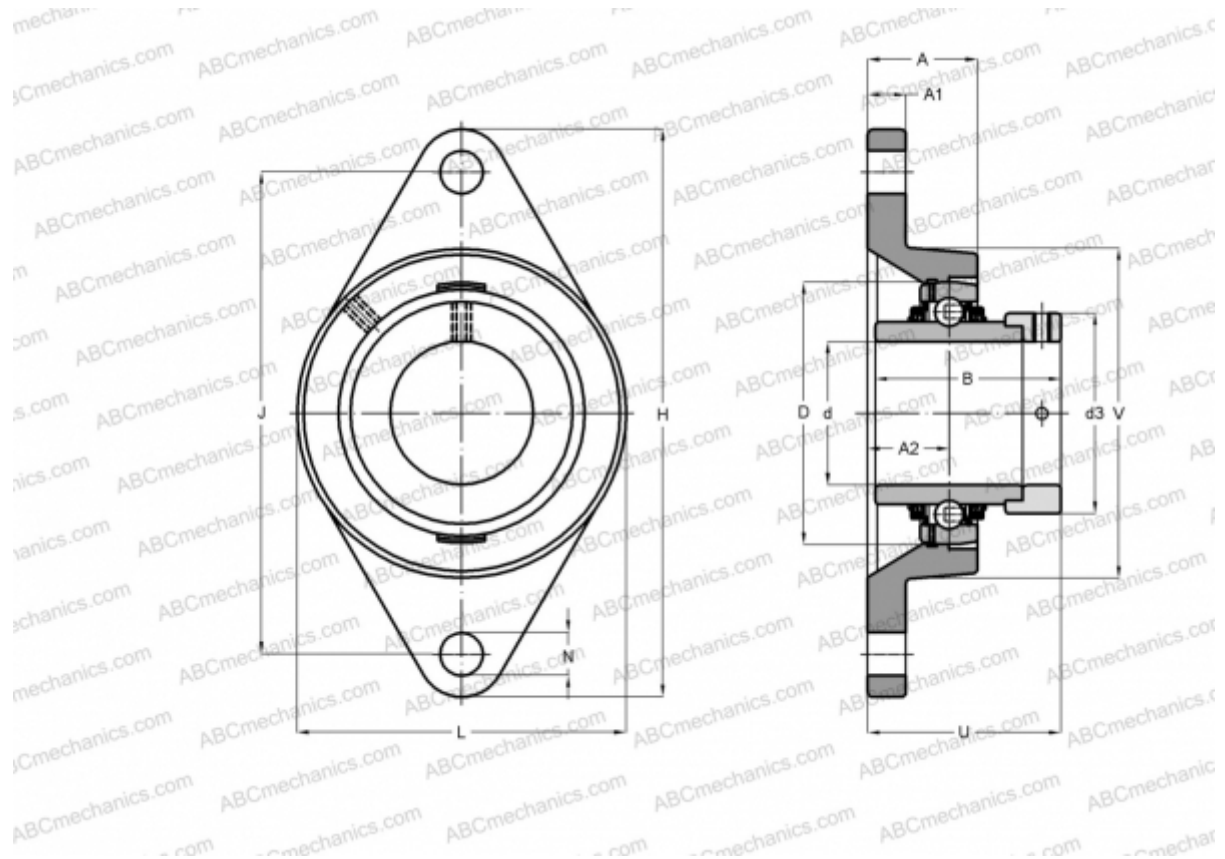

Technical specification

DIMENSIONS, MM

d	45,000
D	85,000
B	56,500
L	111,000
H	180,000
A	35,000
J	148,500
A1	13,000
A2	24,000
N	14,000
d3	63,000
U	59,100
V	111,000
Q	Rp1/8

WEIGHT, KG

	1,920
Bearing	GE45-KTT-B
Housing	GG.CJT09

MANUFACTURER

[INA](#)

CALCULATION DATA

Basic dynamic load rating, C	32,500 kN
Basic static load rating, Co	20,400 kN