

LCJT50-N INA

Ball bearing units

TYPE: Housing units, Two-bolt flanged housing units, Cast iron housing, Radial insert ball bearing with eccentric locking collar, Type LCJT (INA)

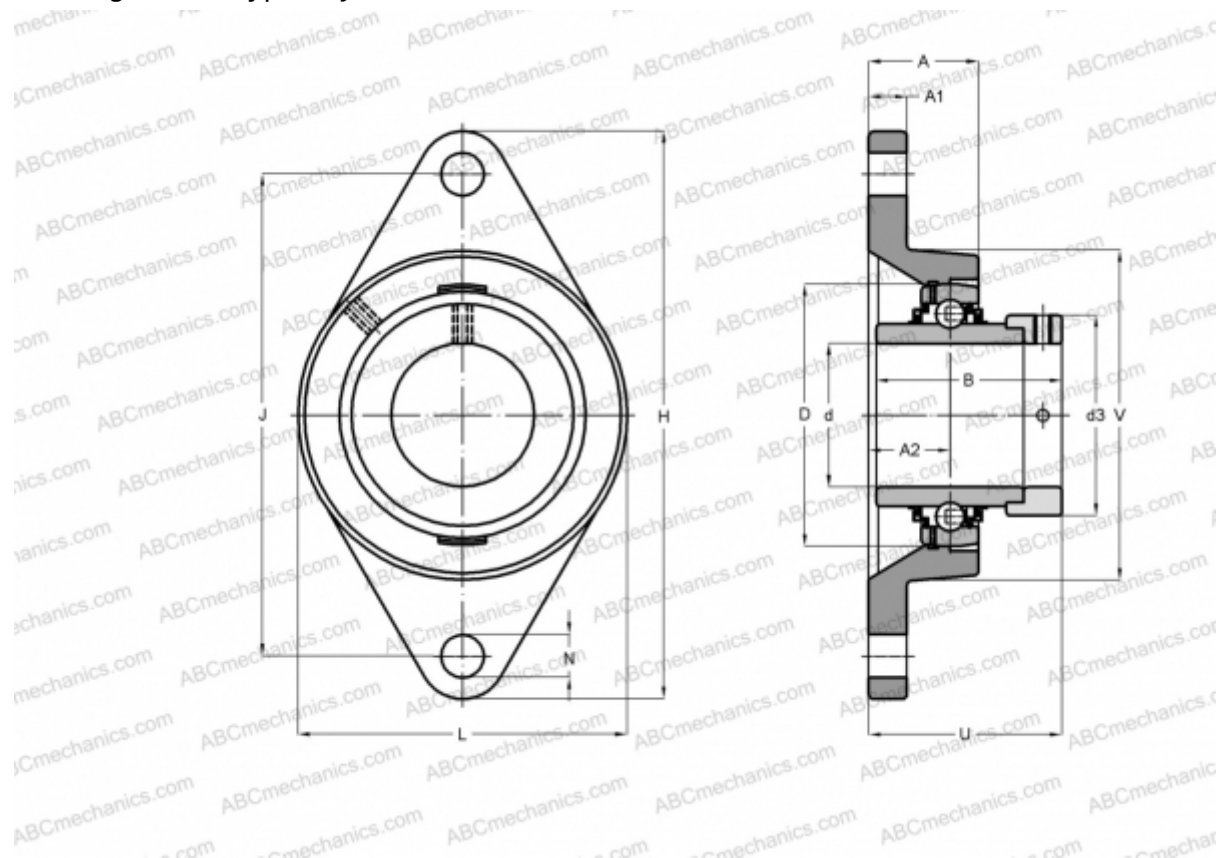

Technical specification

DIMENSIONS, MM

d	50,000
D	90,000
B	62,800
L	116,000
H	190,000
A	39,000
J	157,000
A1	13,000
A2	28,000
N	18,000
d3	69,000
U	66,200
V	116,000
Q	Rp1/8

WEIGHT, KG

2,210

Bearing	GE50-KLL-B
Housing	GG.CJT10-N
Protective cover	KASK10

MANUFACTURER

[INA](#)

CALCULATION DATA

Basic dynamic load rating, C	35,000 kN
Basic static load rating, Co	23,200 kN