

PCJTY12 INA

Ball bearing units

TYPE: Housing units, Two-bolt flanged housing units, Cast iron housing, Radial insert ball bearing with grub screws in inner ring, Type PCJTY (INA)

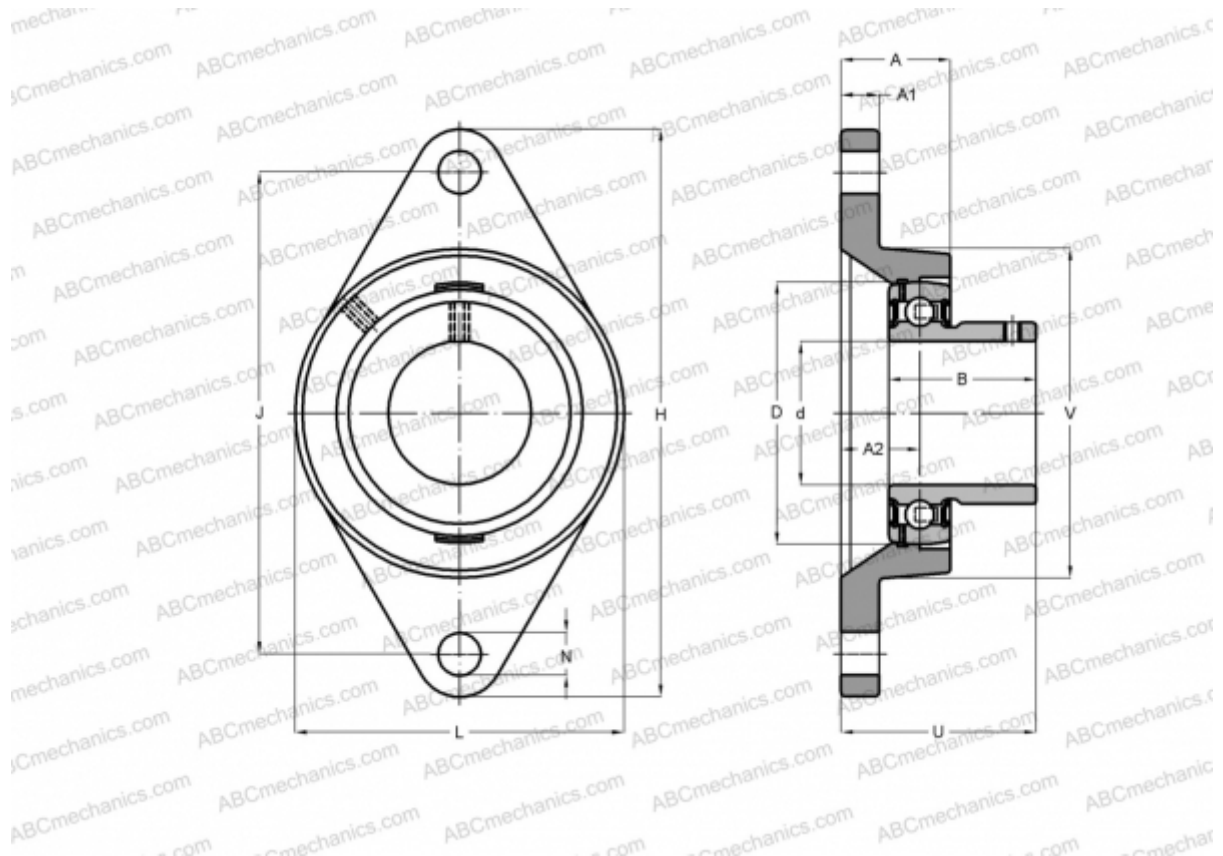

Technical specification

DIMENSIONS, MM

d	12,000
D	40,000
B	22,000
L	57,000
H	99,000
A	25,000
J	76,500
A1	9,500
A2	17,000
N	11,500
U	33,000
V	57,000
Q	M6

Bearing	GAY12-NPP-B
Housing	GG.CJT03

MANUFACTURER

[INA](#)

CALCULATION DATA

Basic dynamic load rating, C	9,800 kN
Basic static load rating, Co	4,750 kN

WEIGHT, KG 0,350