

## PCJTY20-N INA

Ball bearing units

TYPE: Housing units, Two-bolt flanged housing units, Cast iron housing, Radial insert ball bearing with grub screws in inner ring, Type PCJTY (INA)

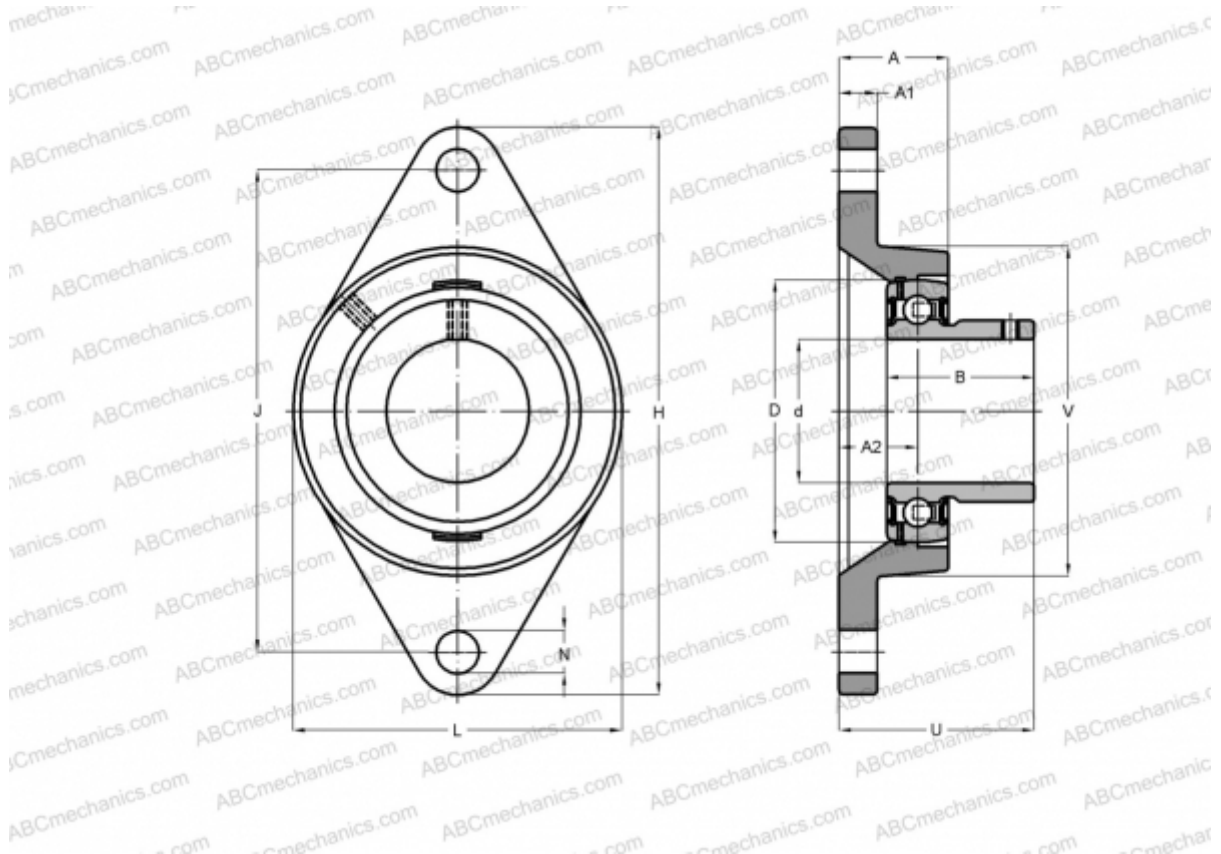

### Technical specification

#### DIMENSIONS, MM

d	20,000
D	47,000
B	25,000
L	61,000
H	112,000
A	28,000
J	90,000
A1	10,000
A2	19,000
N	11,500
U	37,000
V	61,000
Q	Rp1/8

Bearing	GAY20-NPP-B
Housing	GG.CJT04-N
Protective cover	KASK04

#### MANUFACTURER

[INA](#)

#### CALCULATION DATA

Basic dynamic load rating, C	12,800 kN
Basic static load rating, Co	6,600 kN

**WEIGHT, KG** 0,410