

PCJTY60-N INA

Ball bearing units

TYPE: Housing units, Two-bolt flanged housing units, Cast iron housing, Radial insert ball bearing with grub screws in inner ring, Type PCJTY (INA)

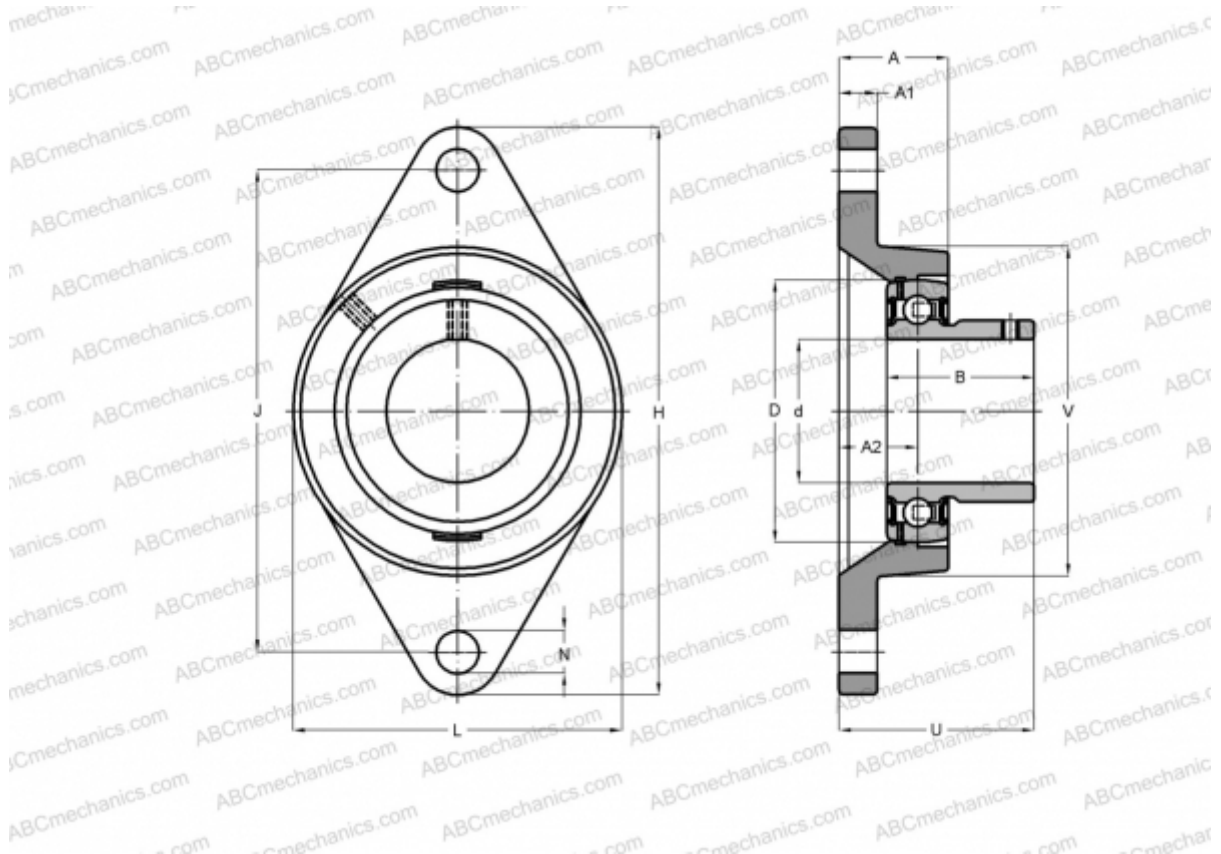

Technical specification

DIMENSIONS, MM

d	60,000
D	110,000
B	47,000
L	138,000
H	238,000
A	46,000
J	202,000
A1	16,000
A2	34,000
N	18,000
U	68,000
V	138,000
Q	Rp1/8

Bearing	GAY60-NPP-B
Housing	GG.CJT12-N
Protective cover	KASK12

MANUFACTURER

[INA](#)

CALCULATION DATA

Basic dynamic load rating, C	52,000 kN
Basic static load rating, Co	36,000 kN

WEIGHT, KG 2,920