

RCJTY25-N INA

Ball bearing units

TYPE: Housing units, Two-bolt flanged housing units, Cast iron housing, Radial insert ball bearing with grub screws in inner ring, Type RCJTY (INA)

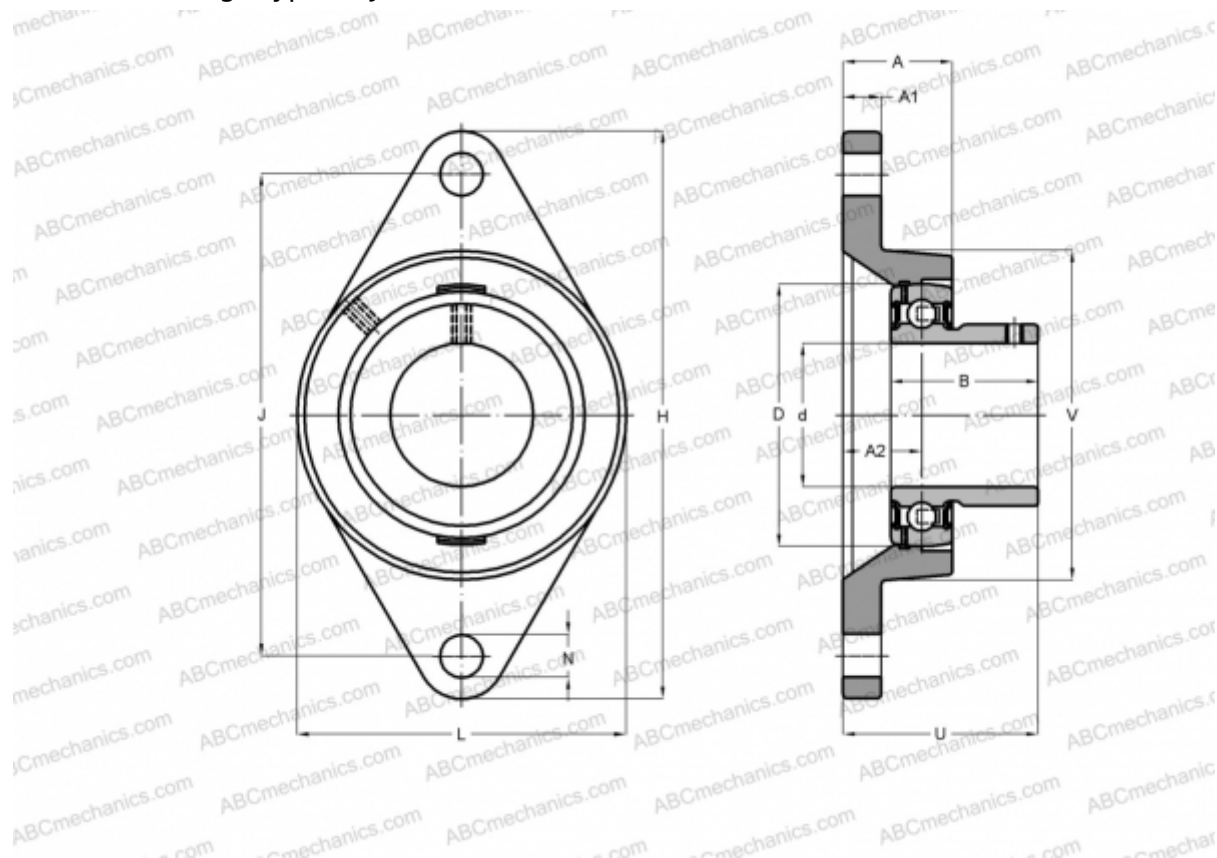

Technical specification

DIMENSIONS, MM

d	25,000
D	52,000
B	34,100
L	70,000
H	124,000
A	26,500
J	99,000
A1	11,000
A2	19,000
N	11,500
U	38,800
V	70,000
Q	Rp1/8

WEIGHT, KG 0,570

Bearing	GYE25-KRR-B
Housing	GG.CJT05-N
Protective cover	KASK05

MANUFACTURER

[INA](#)

CALCULATION DATA

Basic dynamic load rating, C	14,000 kN
Basic static load rating, Co	7,800 kN