

RCJTY45 INA

Ball bearing units

TYPE: Housing units, Two-bolt flanged housing units, Cast iron housing, Radial insert ball bearing with grub screws in inner ring, Type RCJTY (INA)

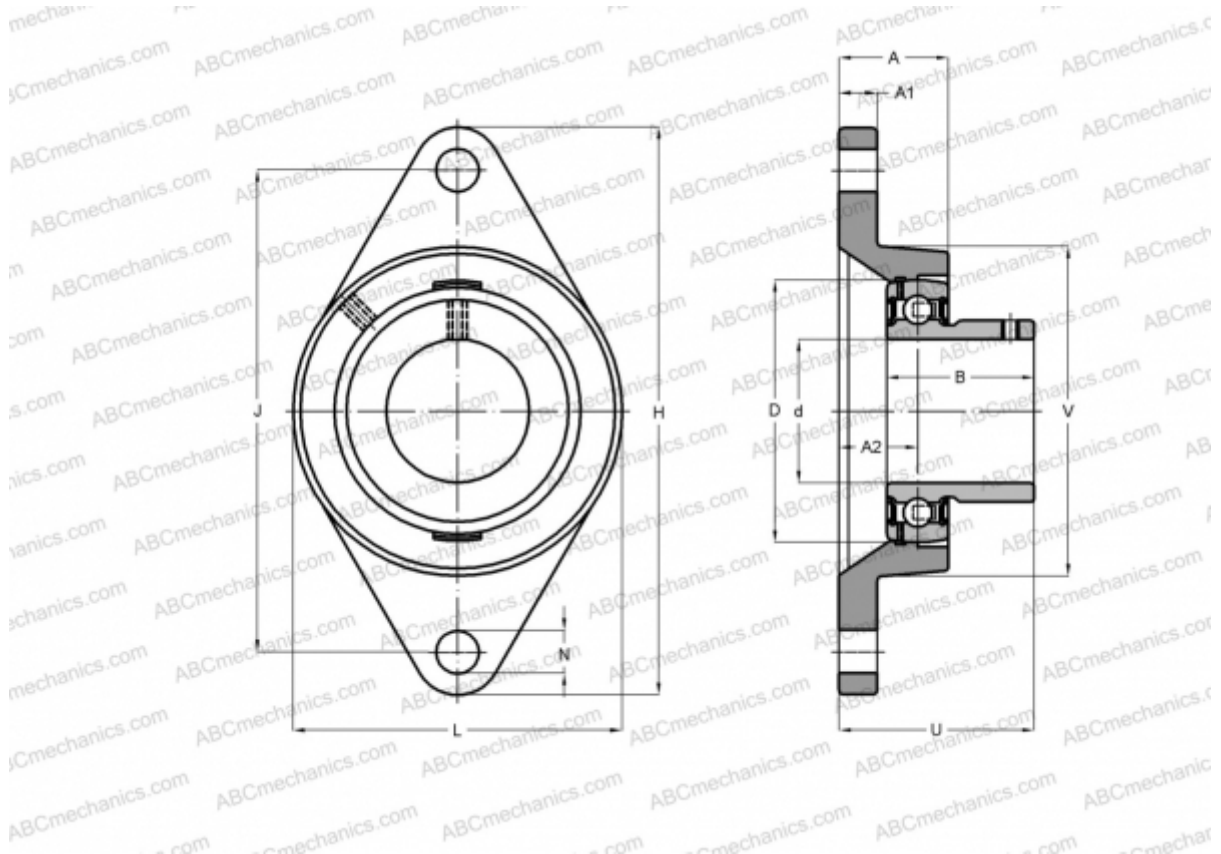

Technical specification

DIMENSIONS, MM

d	45,000
D	85,000
B	49,200
L	111,000
H	180,000
A	35,000
J	148,500
A1	13,000
A2	24,000
N	14,000
U	54,200
V	111,000
Q	Rp1/8

Bearing	GYE45-KRR-B
Housing	GG.CJT09

MANUFACTURER

[INA](#)

CALCULATION DATA

Basic dynamic load rating, C	32,500 kN
Basic static load rating, Co	20,400 kN

WEIGHT, KG 1,700