

RAT25 INA

Ball bearing units

TYPE: Housing units, Two-bolt flanged housing units, Sheet steel housing, Radial insert ball bearing with eccentric locking collar, Type RAT (INA)

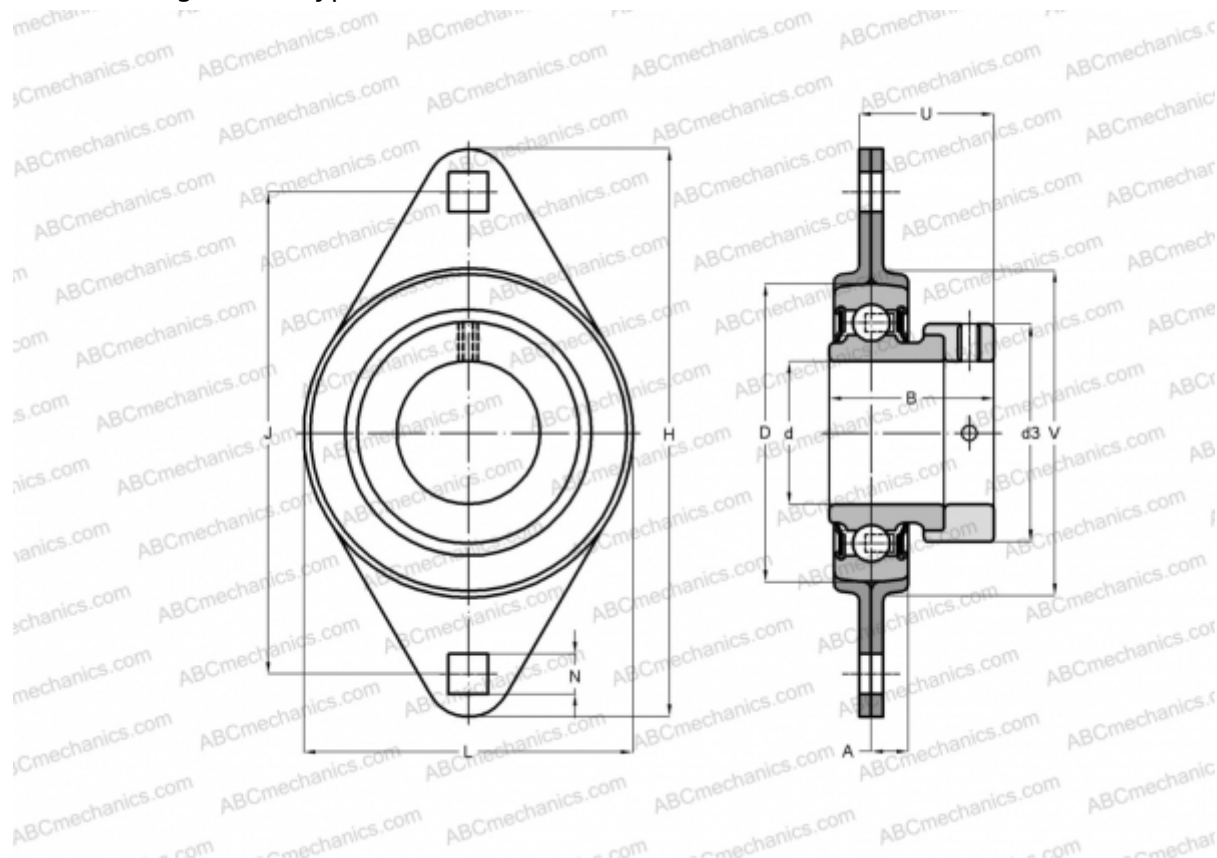

Technical specification

DIMENSIONS, MM

d	25,000
D	52,000
B	31,000
L	71,000
H	95,200
A	8,700
J	76,200
N	8,700
d3	37,500
U	25,500
V	60,000

WEIGHT, KG 0,340

Bearing RAE25-NPP-B

Housing FLAN52-MST x

MANUFACTURER

2
[INA](#)

CALCULATION DATA

Basic dynamic load rating, C	14,000 kN
Basic static load rating, Co	7,800 kN