

RAT40 INA

Ball bearing units

TYPE: Housing units, Two-bolt flanged housing units, Sheet steel housing, Radial insert ball bearing with eccentric locking collar, Type RAT (INA)

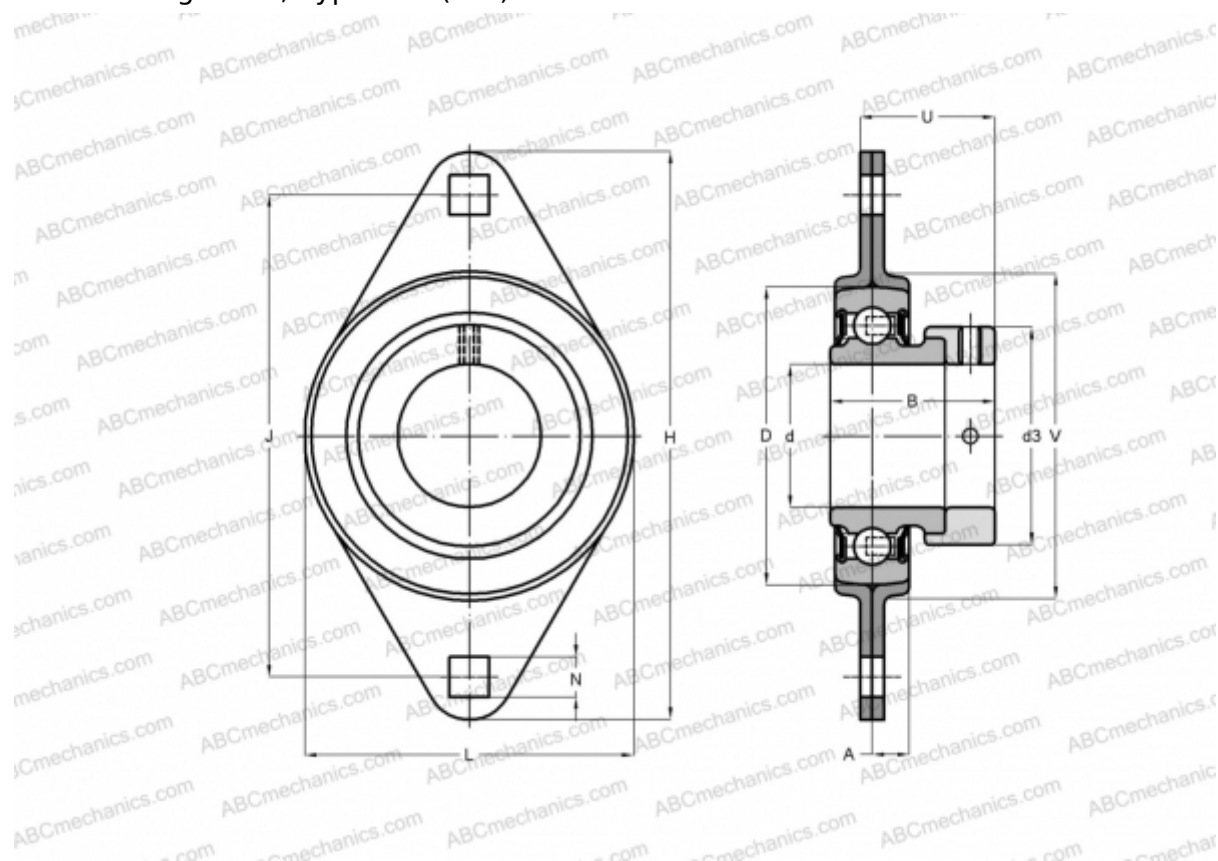

Technical specification

DIMENSIONS, MM

d	40,000
D	80,000
B	43,800
L	100,000
H	151,000
A	11,500
J	119,000
N	13,500
d3	58,000
U	36,200
V	90,000

WEIGHT, KG 0,980

Bearing RAE40-NPP-B

Housing FLAN80-MST x

MANUFACTURER

2
[INA](#)

CALCULATION DATA

Basic dynamic load rating, C	32,500 kN
Basic static load rating, Co	19,800 kN