

PCSLT25 INA

Ball bearing units

TYPE: Housing units, Two-bolt flanged housing units, Sheet steel housing, Radial insert ball bearing with eccentric locking collar, Type PCSLT (INA)

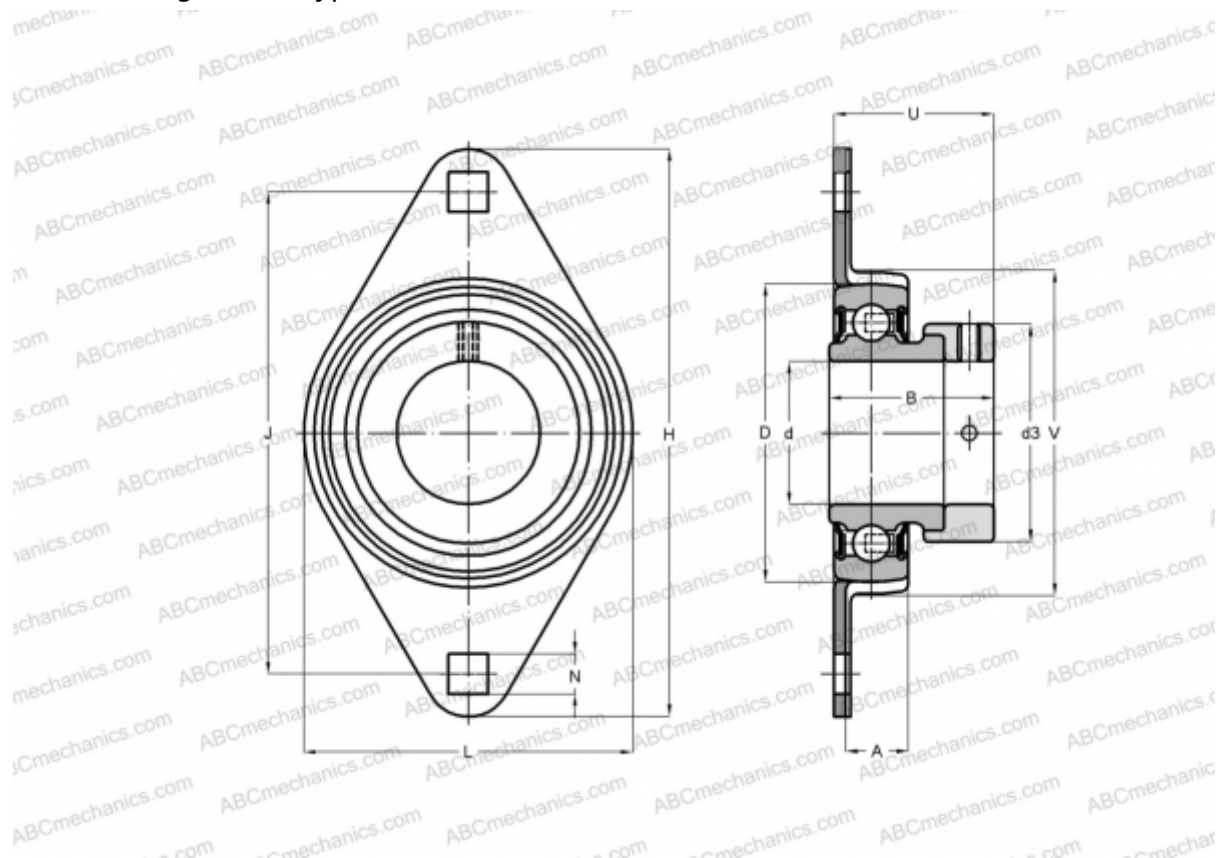

Technical specification

DIMENSIONS, MM

d	25,000
D	47,000
B	25,400
L	71,000
H	95,200
A	16,000
J	76,200
N	8,700
d3	36,000
U	28,000

WEIGHT, KG 0,250

Bearing	RALE25-NPP-B
Housing	FLAN47-CSLT-FA125/FLAN47-CST-FA125 x 1

MANUFACTURER

[INA](#)

CALCULATION DATA

Basic dynamic load rating, C	10,100 kN
Basic static load rating, Co	5,900 kN