

PCFTR15 INA

Ball bearing units

TYPE: Housing units, Three-bolt flanged housing units, Cast iron housing, Radial insert ball bearing with eccentric locking collar, Type PCFTR (INA)

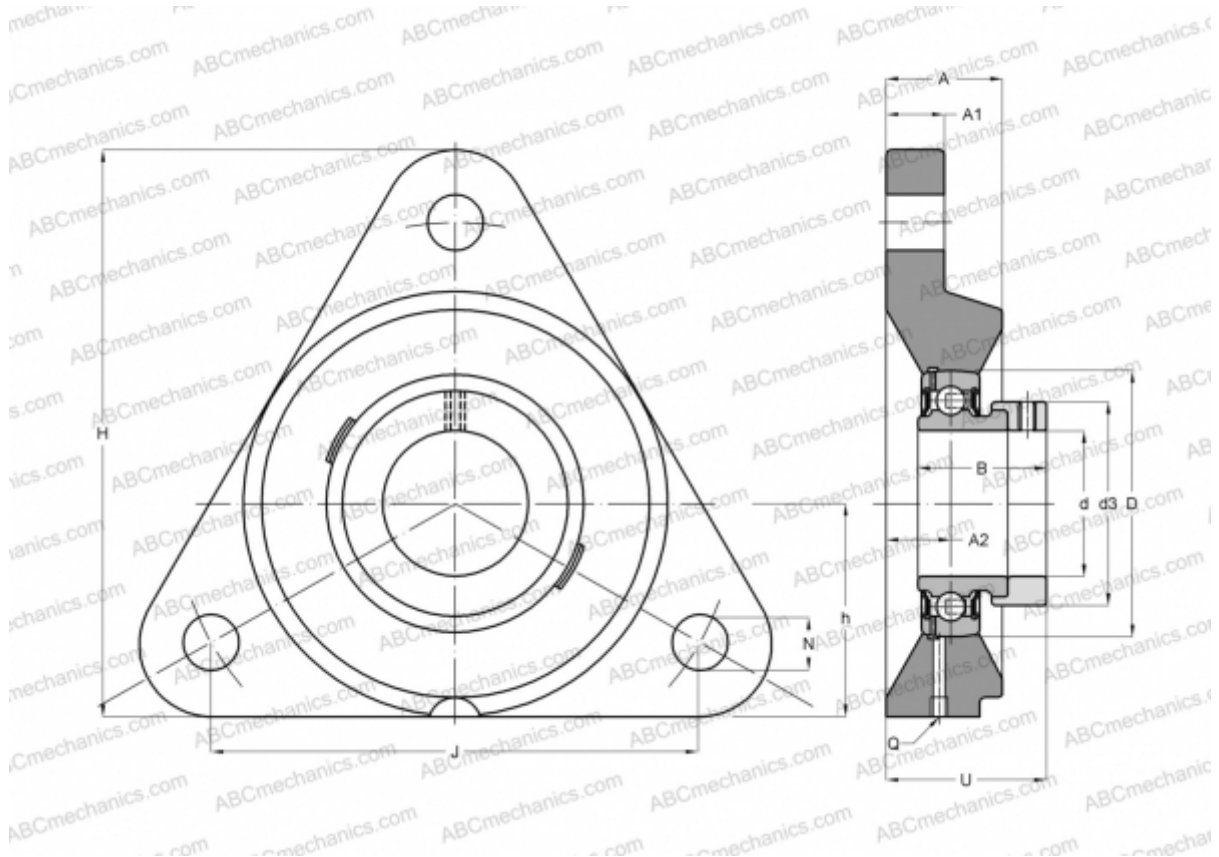

Technical specification

DIMENSIONS, MM

d	15,000
D	40,000
B	28,600
H	81,000
A	20,000
J	76,100
A1	11,000
A2	10,000
N	11,500
d3	28,000
U	32,100
h	31,000
Q	M6

Bearing	GRAE15-NPP-B
Housing	GG.CFTR03

MANUFACTURER

[INA](#)

CALCULATION DATA

Basic dynamic load rating, C	9,800 kN
Basic static load rating, Co	4,750 kN

WEIGHT, KG 0,400