

## PCFTR20 INA

Ball bearing units

TYPE: Housing units, Three-bolt flanged housing units, Cast iron housing, Radial insert ball bearing with eccentric locking collar, Type PCFTR (INA)

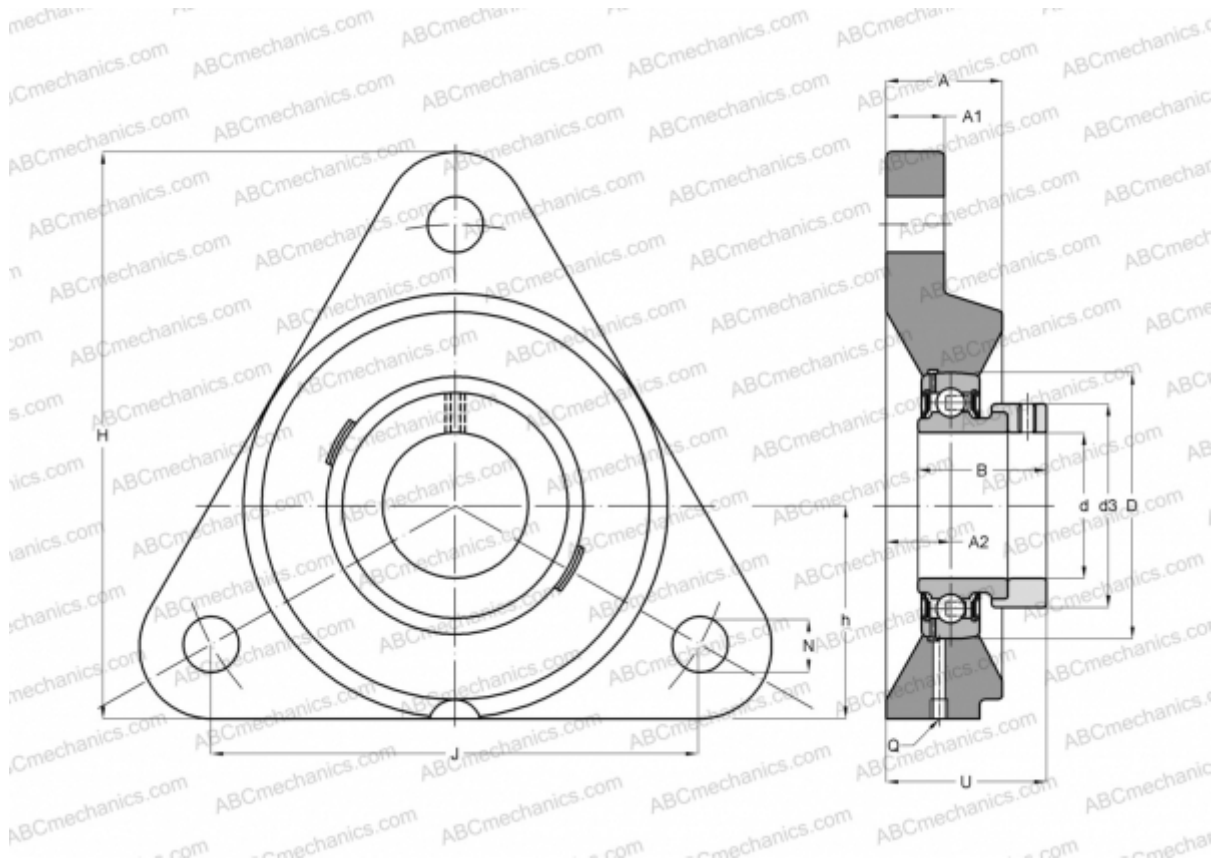

### Technical specification

#### DIMENSIONS, MM

d	20,000
D	47,000
B	31,000
H	92,000
A	20,000
J	89,500
A1	11,000
A2	10,500
N	11,500
d3	33,000
U	34,000
h	35,000
Q	Rp1/8

Bearing	GRAE20-NPP-B
Housing	GG.CFTR04

#### MANUFACTURER

[INA](#)

#### CALCULATION DATA

Basic dynamic load rating, C	12,800 kN
Basic static load rating, Co	6,600 kN

**WEIGHT, KG** 0,560