

## PCFTR50 INA

Ball bearing units

TYPE: Housing units, Three-bolt flanged housing units, Cast iron housing, Radial insert ball bearing with eccentric locking collar, Type PCFTR (INA)

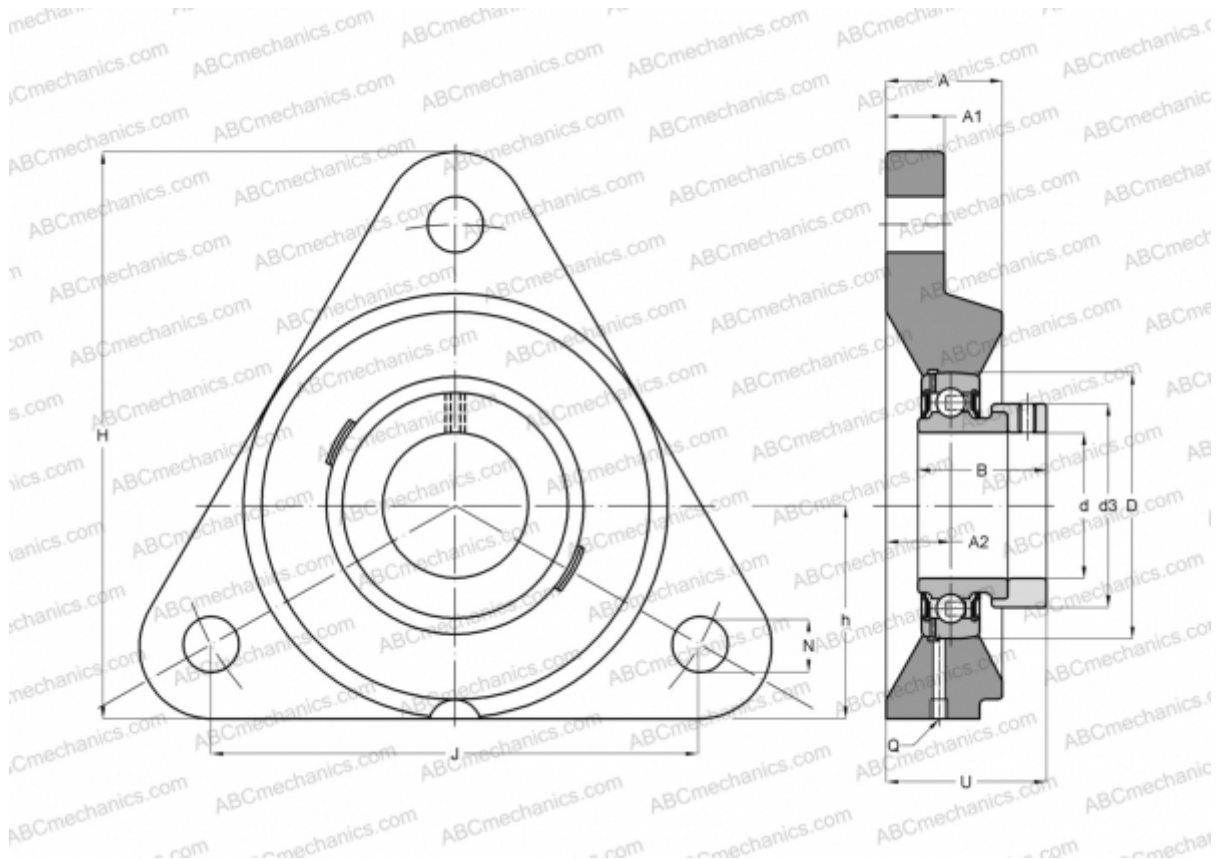

### Technical specification

#### DIMENSIONS, MM

d	50,000
D	90,000
B	43,800
H	150,000
A	33,000
J	160,000
A1	16,000
A2	19,200
N	14,000
d3	69,000
U	51,900
h	55,000
Q	Rp1/8

Bearing	GRAE50-NPP-B
Housing	GG.CFTR10

#### MANUFACTURER

[INA](#)

#### CALCULATION DATA

Basic dynamic load rating, C	35,000 kN
Basic static load rating, Co	23,200 kN

**WEIGHT, KG** 2,150